

Annual Report 2012

Institute for Surgical Technology and Biomechanics
ARTORG Center for Biomedical Engineering Research

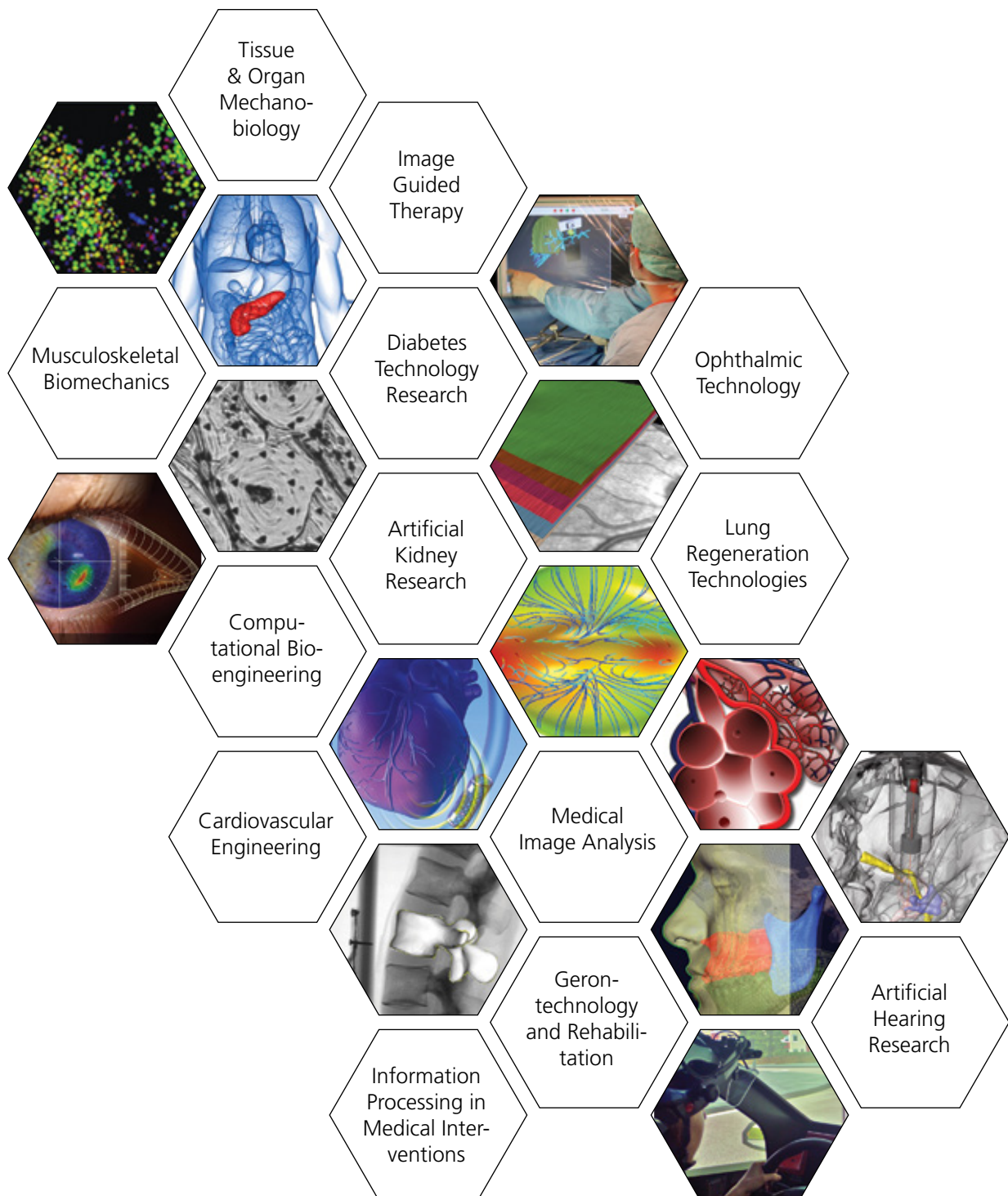

CONTENTS

Editorial	4
Biomedical Engineering Research at the University of Bern and the Inselspital	5

Institute for Surgical Technology and Biomechanics

Organization	7
Computational Bioengineering	8
Information Processing in Medical Interventions	10
Medical Image Analysis	12
Musculoskeletal Biomechanics	14
Tissue & Organ Mechanobiology	16

ARTORG Center for Biomedical Engineering Research

Organization	19
Artificial Hearing Research	22
Artificial Kidney Research	24
Cardiovascular Engineering	26
Diabetes Technology Research	28
Gerontechnology and Rehabilitation	30
Image Guided Therapy	32
Lung Regeneration Technologies	34
Ophthalmic Technology	36

Joint Scientific Facilities

Mechanical Design and Production	39
Opto-Acoustic Laboratory	41
Demonstration and Test OR	41
Driving Simulation Laboratory	41
Computer Simulation & Modeling	42
PDMS and Hot Embossing Rapid Prototyping Equipment	42
Microscopy for Imaging of Material and Biological Samples	42
Biomechanics Laboratory	43
Rapid Prototyping Laboratory	43
Electronics Laboratory	43
Dry and Wet Laboratories	43
The Virtual Skeleton Database	44

Acknowledgments	45
Completed Dissertations	47
Awards	47

EDITORIAL

We are very happy and proud to pass to you the first joint annual report of the Institute for Surgical Technology and Biomechanics (ISTB) and the Artificial Organ Center for Biomedical Engineering Research (ARTORG). This effort reflects our long-standing and close scientific collaboration as well as the need for a focussed representation of all ongoing research activities in biomedical engineering at the University of Bern. To this end, this report not only introduces to you the research activities of the ISTB (pages 7-17) and the ARTORG Center (pages 19-37) but also features a "compass" page (page 5), highlighting other selected research activities in the field at either our university or the Bern University Hospital, Inselspital. Together with a comprehensive introduction to our joint research facilities we strive to provide an overview of our strong methodological competencies at the University of Bern.

Following our strategic vision to advance healthcare by integrating education, discovery, innovation and entrepreneurship the University of Bern has established itself as a relevant player both on a national and international level in the biomedical engineering research domain during the past years. To date, ISTB and ARTORG are contributing to a wide variety of projects funded by European programs (FP7 and Eurostars), the Confederation's innovation promotion agency CTI and through various SNF funding schemes. Both centers continue to host core-groups affiliated with the SNF funded National Center in Research Co-Me. In addition collaborative projects with the Med-Tech industry and non-governmental organizations continue to be developed. Our multidisciplinary team of more than 130 scientists has been able to successfully continue our translational research activities in all of our focus areas, along with our strong ties to the clinical divisions of the university hospital, Inselspital Bern and external partners national and international.

We have come to realize, that the established novel partnership and multifaceted collaboration between technologists and clinicians is becoming a somewhat role model in our community. This is also reflected by the fact that the number of members of the medical faculty with a technological background is growing with the expanding research portfolio.



Stefan Weber
Director
ARTORG Center for Biomedical Engineering Research

For the research groups of the ISTB, 2012 was a year of continuous consolidation. Maintaining external funding at a high level we have been able to continue research activities in all of our focus areas. Mauricio Reyes obtained his habilitation, so that all of our group heads can now be active as independent teachers (PD). We could also celebrate the inauguration of our new biomechanics testing facilities allowing analyses down to the nanoscale. With all our groups involved in statistical shape modeling and recent developments of the virtual skeleton database (www.virtualskeleton.ch) a significant number of collaborations with research and industrial partners could be established, making the ISTB a reference center in this field.

In 2012 the ARTORG Center continued its consolidation with the appointment of Stefan Weber as full professor for image-guided therapies at the medical faculty and as the new director of the center. Currently the process for the new professorship for cardiovascular engineering is in its final stage. The research groups concerned with artificial hearing, ophthalmic technology, gerontechnology and rehabilitation engineering, diabetes technology as well as image-guided therapy have received positive recommendations to further continue their research within the center. We are now looking forward to the assessment of the scientific performance of the remaining groups in the upcoming months.

In 2012 ISTB and ARTORG Center continued their activities in training undergraduates, graduate students, and postdoctoral fellows for future leadership roles in teaching, research, and industry. Our Master of Science in Biomedical Engineering program (www.BIOENG.Master.unibe.ch) continues to attract students nationally and internationally, the 7th class recently starting with 45 new students. Currently, nearly 150 students are enrolled in the program to become specialists in biomedical engineering. In addition, about 40 students from the ISTB and the ARTORG Center are currently enrolled in the interdisciplinary biomedical science doctoral program (www.gcb.unibe.ch).



Lutz Nolte
Director
Institute for Surgical Technology and Biomechanics

BIOMEDICAL ENGINEERING RESEARCH AT THE UNIVERSITY OF BERN AND THE INSELSPITAL

The University of Bern and Bern University Hospital host a variety of research groups concerned with specialized topics within the field of biomedical engineering. This page provides a selection of some of the currently active groups.

Advanced Neuroimaging Group
Department for diagnostic and interventional neuroradiology, Inselspital
Head: Roland Wiest
The workgroup focuses on the development, clinical implementation and validation of novel CT and MR based technologies that aid in the diagnosis of CNS disorders.

Neurovascular Treatment Group
Department for diagnostic and interventional neuroradiology, Inselspital
Head: Jan Gralla
The group investigates the evaluation of neurovascular diseases including the in-vivo development and application of endovascular treatment techniques.

Inner Ear Research Laboratory
Department of Otorhinolaryngology, Head & Neck Surgery, Inselspital
Head: Pascal Senn
The inner ear research laboratory employs stem cell and nanotechnology to improve cochlear implant systems and develop future hearing loss therapies based on regenerative principles.

Bronchoscopy Unit
Department of Respiratory Medicine, Inselspital
Head: Christophe von Garnier
The research interests of the unit include the integration of multiple imaging modalities (PET-CT, conventional CT, ultrasound) for navigated bronchoscopies.

Department of Biomedical Photonics
Institute of Applied Physics
Head: Martin Frenz
The group develops novel optical tomographic imaging modalities and laser procedures for medical diagnosis and treatment of diseases.

Division of Medical Radiation Physics
Department of Radiation Oncology, Inselspital
Head: Peter Manser
Next to implementation of new methods in radiation therapy, the group addresses fundamental research in medical radiation physics.

Magnetic Resonance Spectroscopy and Methodology
Department of Clinical Research, Inselspital
Head: Chris Boesch
The group works on methodological developments and applications of magnetic resonance imaging (MRI) and spectroscopy (MRS) in humans.

ISTB
Pages: 7 - 17

ARTORG
Pages: 19 - 37



ORGANIZATION

Institute for Surgical Technology and Biomechanics

Management



L. P. Nolte
Director



Ph. Zysset
Co-Director

Administration



K. Fahnenmann-Nolte



A. Neuenschwander



B. Schmitter

IT-Support



H. Studer



H. Lu

Mechanical Design and Production



U. Rohrer

Scientific Groups



P. Büchler
Computational Bioengineering



G. Zheng
Information Processing in Medical Interventions



L. P. Nolte
Information Processing in Medical Interventions



M. Reyes
Medical Image Analysis



Ph. Zysset
Musculoskeletal Biomechanics



B. Gantenbein
Tissue & Organ Mechanobiology

Master of Science in Biomedical Engineering



Ph. Zysset
Program Director



U. Jakob-Burger
Study Coordinator



A. Neuenschwander Salazar
Study Coordinator



J. Spyra
Study Coordinator

Computational Bioengineering

Philippe Büchler, Head of Research Group

Email: philippe.buechler@istb.unibe.ch

Phone: +41 31 631 59 47



Philippe
Büchler



Brett
Bell



Farid
Dshabarow



Marcelo Elias
de Oliveira



Can
Gökgöl



Michael
Kistler



Simon
Roder

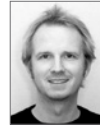

Christoph
Reutlinger



Manuel
Stebinger



Harald
Studer



Elham
Taghizadeh

Research Profile

The Computational Bioengineering Group tackles challenges in basic and applied medical research with modern computational simulation tools. Rather than focusing on the computational methods themselves, we are concerned with their appropriate application for the resolution of practical and fundamental clinical questions. Numerical methods are combined with experimental and clinical research in order to improve the quality and extend the validity of our models.

Together with our collaborators, we constitute a strong team covering a wide spectrum of research topics ranging from direct support of surgical patient treatment to basic cell research. Besides our core expertise in applying finite element analysis to study skeletal biomechanics, we are seeking to improve planning of various computer aided interventions by developing and applying refined numerical techniques into the field of computer aided surgery. Another important research focus of the group is the development of novel statistical finite element methods for the incorporation of uncertainty in bone shape and mechanical properties into the evaluation of bone biomechanics.

Statistical Modeling for Biomechanical Simulations

Finite element models built from CT data are commonly used to evaluate the mechanical performance of the bone

or the load transfer from the implant to the bone. However, most analyses overlook the wide variation in material properties and geometry that may occur in natural tissues or the manufacturing imperfections in synthetic materials.

During the last year, we developed a method to combine a statistical description of bone biomechanics based on pre-calculated FE simulations to accelerate patient-specific mechanical calculations. The traditional process required to build numerical models and run FE calculations is time consuming and prevents the clinical acceptance of patient-specific simulations. Our approach provides patient-specific mechanical data without additional time-consuming simulations. The proposed method was evaluated on the femur loaded according to a normal walking situation. Results showed that the proposed method is able to instantaneously provide the distribution of bone stresses with a prediction error below 0.1 MPa and of nodal displacements with an error of less than 70 μm .

Biomechanics of the Scoliotic Spine

Non-fusion operative methods for the treatment of degenerative spinal diseases have tremendous potential to increase patient quality of life. In addition to the fact that motion is preserved or restored, a natural load transfer to the adjacent segments is sustained. This is important, as clinical experience shows that fusion of motion segments

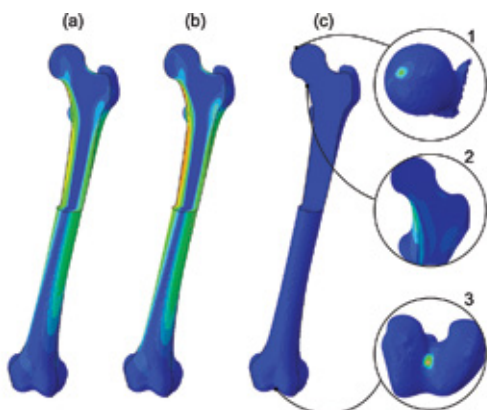

A method to accelerate the calculation of bone stresses has been proposed. The von Mises stresses obtained instantaneously with this technique (a) are equivalent to the values obtained with the full finite element calculations (b). The absolute error distribution (c) showed that the results are identical for all calculation points except for a few regions with higher errors (1-3).

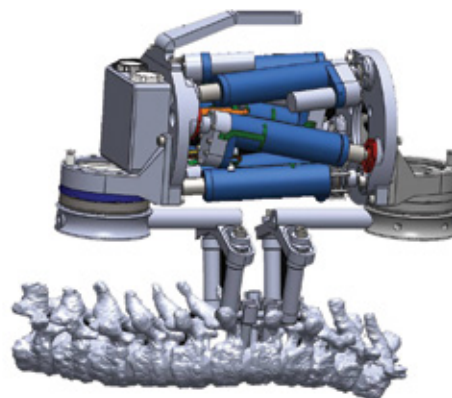

A robotic system was developed to measure the spinal mechanical properties intra-operatively. The system will provide stiffness information in lateral bending, flexion and axial rotation.

frequently can entail adjacent level degeneration. However, non-fusion implants are challenging, particularly for the treatment of spinal deformities, in which several segments are commonly affected. A better understanding of the mechanical properties of healthy and pathological motion segments is essential.

Over the past years, an apparatus has been developed that enables the intraoperative quantification of mechanical behavior of spinal motion segments. Preliminary results showed that the mean flexibility of the segments was lower on the concave than on the convex side. However, additional information is required to provide a complete mechanical description. For this reason, a robotic system, providing a high level of accuracy in force/displacement measurements, is being developed to perform intra-operative measurements.

For the planning of interventions, surgeons require a pre-operative assessment of the biomechanical behavior of the patient's scoliotic spine. Nowadays, only limited data is available on the complex functional behavior and stiffness of the degenerated segments under physiological loads, because existing studies have focused solely on the spinal kinematics without considering mechanical loads. Therefore, we have developed a measurement technique that is able to provide surgeons with a three-dimensional assessment of the spine flexibility, suitable for daily clinical



A spinal loading system has been designed to quantitatively assess the biomechanical properties of the patients' spine before scoliotic correction surgery.

Selected Publications

Elsheikh A, Whitford C, Hamarashid R, Kassem W, Joda A, Büchler P (2013) Stress free configuration of the human eye. *Med Eng Phys* 2:211-216

Lüthi M, Blanc R, Albrecht T, Gass T, Goksel O, Marcel L, Kistler M et al (2012) Statismo - A framework for PCA based statistical models. *Insight J* 1-18 <http://hdl.handle.net/10380/3371>

Reutlinger C, Hasler C, Scheffler K, Büchler P (2012) Intraoperative determination of the load-displacement behavior of scoliotic spinal motion segments: preliminary clinical results. *Eur Spine J* 21(S6):S860- S867

Studer H P, Riedwyl H, Amstutz CA, Hanson JVM, Büchler P (2013) Patient-specific finite-element simulation of the human cornea: A clinical validation study on cataract surgery. *J Biomech* 46(4):751- 758

Studer H, Riedwyl H, Büchler P (2012) Importance of multiple loading scenarios for the identification of material coefficients of the human cornea. *Comput Methods Biomech Biomed Engin* 15(1):93-99

use. A method based on standing elevation of the patient has been developed and is currently being evaluated clinically.

Superficial Femoral Artery

The femoropopliteal segment at the knee is exposed to complex multi-axial deformations as the leg is bent. Correspondingly, a stent deployed in these arteries undergoes substantial displacements from pulsatile motion, as well as bending, torsion, and axial motions during a walking cycle. Thus, a metal stent in this arterial environment has a significant risk of fracture, which has been associated with higher in-stent restenosis and re-occlusion rates. Despite recent improvements in stent design, the basic biomechanical properties of the diseased femoropopliteal arterial intersection remain only poorly understood.

The purpose of this study is to provide a better understanding of the mechanical constraints acting on the femoropopliteal arteries during motions of the leg. The first step was to quantify the arterial deformations induced by normal walking on healthy volunteers and patients before stenting. Three-dimensional imaging techniques were used to record the arterial tree before and after flexion of the leg. The basic arterial deformations were quantified for axial rotation, bending and contraction. Based on this information, finite element models are being developed to enable virtual testing of new stent designs.

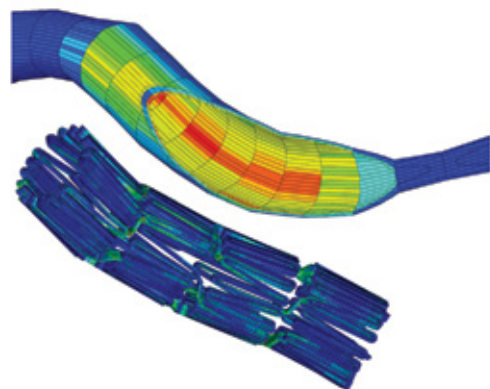

The deformation of the femoropopliteal artery measured on patients is used to enable virtual testing of new stents.

Information Processing in Medical Interventions

Guoyan Zheng, Lutz-Peter Nolte

Email: guoyan.zheng@istb.unibe.ch; lutz.nolte@istb.unibe.ch

Phone: +41 31 631 59 51



Guoyan Zheng

Lutz-P. Nolte

Steffen Schumann

Cheng Chen

Weiguao Xie

Li Liu

Weimin Yu

Risto Kojcev

Marta Valenti

Benedikt Thelen

Steven Balestra

Georgios Aprilis

Nadieh Khalili

Research Profile

A large and growing family of medical interventions involves the processing of information in different stages of the interventions such as pre-operative planning, intra-operative treatment and post-operative control. Typical examples include the derivation of patient-specific anatomical models from pre-operative medical images, the calibration of intra-operative imaging devices and surgical instruments, the registration of medical images to patient's physical space, the display of position and trajectory on those images and the measurements of treatment results from post-operative medical images. The Information Processing in Medical Interventions (IPMI) Group focuses on development of smart information processing methods and enabling technologies to solve challenging problems of medical interventions in clinical routine. In 2012 we continued our pursuit of novel information processing methodologies/systems for various applications.

iJoint: 2D/3D reconstruction of patient-specific hip joint from conventional X-ray radiographs

Conventional X-ray radiography is the standard imaging method for the majority of hip applications. Although it has an inferior accuracy in comparison to 3D techniques based on CT or MRI, it is used routinely because of its simplicity, availability, and the minimal expenses associated with image acquisition. While normal X-ray radiographs are easily obtained, their accurate interpretations are subject to substantial errors. In order to perform quantitative measurements based on these images we have developed and patented a lightweight X-ray calibration unit. The calibration unit is simply placed close to the patient during X-ray image acquisition in order to retrieve accurate radiographic information. This allows a patient-specific

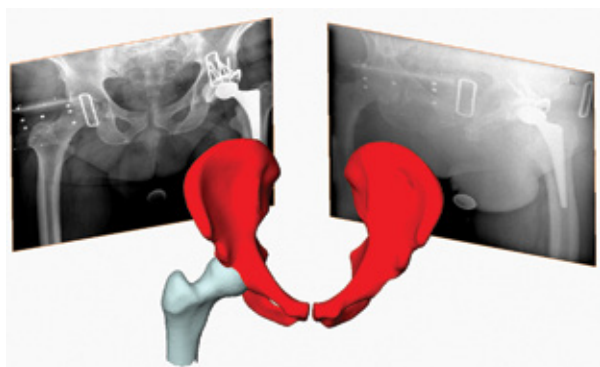

Schematic view of 2D/3D reconstruction of hip joint from conventional X-ray radiographs.

3D model of the hip joint, based on statistical shape models of the femur and pelvis, to be reconstructed. In collaboration with clinical and industrial partners, a novel total hip arthroplasty planning software based on the patient-specific models reconstructed from X-ray images is under development and will be ready to use for surgeons by middle of 2013.

iLeg: 2D/3D reconstruction of lower extremity from clinically available X-rays

During the last year the focus of the iLeg project has been the development of machine learning-based fully automatic X-ray image segmentation algorithms, and the development of a 2D/3D reconstruction method that allows for reconstructing patient-specific 3D models of the lower extremity from clinically available X-rays for true 3D planning and evaluation of surgical interventions at the knee. Evaluated on 6 patient datasets and taking models derived from MRI scans of the knee as a ground truth, an average reconstruction accuracy of 1.2 mm and an average reconstruction accuracy of 1.0 mm were achieved for the distal femur and the proximal tibia, respectively. Recently we extended our methodology for the reconstruction of both lower extremities from one single standing X-ray radiograph.

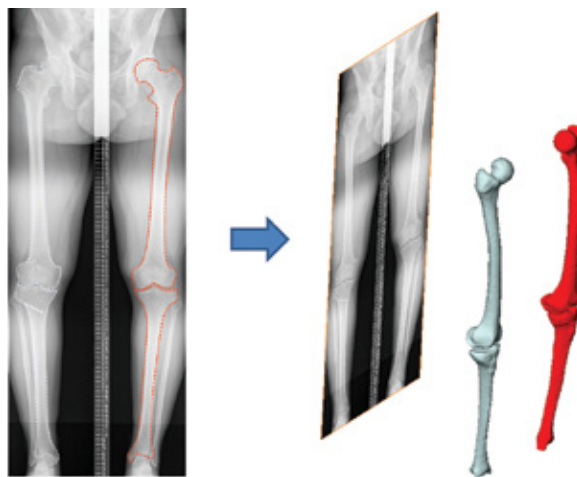

Schematic view of 2D/3D reconstruction of both lower extremities from a single long-standing X-ray radiograph.

Clinical applications of X-ray calibration and 2D/3D reconstruction

In collaboration with the Computational Bioengineering group we applied our X-ray calibration and 2D/3D reconstruction techniques in two different clinical scenarios. The first is for the surgical correction of idiopathic scoliosis,

which requires the knowledge of the patient-specific mechanical properties of the spine. This project involves the development of an X-ray based 2D/3D reconstruction system for measuring the relative motion of the vertebral bodies in 3D for a biomechanical assessment of the spinal stiffness. The second application is for stent insertion in treatment of lower extremity peripheral arterial disease (PAD). The goal is to develop a method for 3D reconstruction of the arterial shape from two angiographic X-ray radiographs. For both applications a previously developed lightweight X-ray calibration unit was used to calibrate

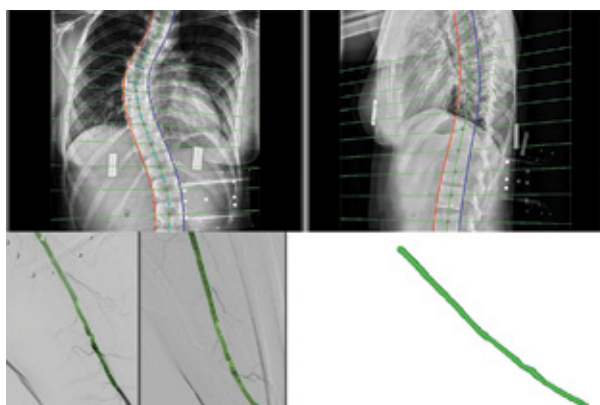

Clinical applications of X-ray calibration and 2D/3D reconstruction. Top row: X-ray calibration and 2D/3D reconstruction for the surgical correction of idiopathic scoliosis; bottom row: X-ray calibration and 2D/3D reconstruction for stent insertion in treatment of the lower extremity peripheral arterial disease (PAD).

the acquired X-ray images and custom 2D/3D reconstruction programs developed.

Statistical shape modeling of human shoulder joint

In this project, together with the Department of Orthopaedic Surgery at Inselspital, we aim to use statistical shape modeling to create workflows for automatically extracting, representing and analyzing the morphological variations of human shoulder joints in large populations. Statistical shape modeling has the ability to decompose the modes of the shape variations present in a training set using relatively few parameters. In the previous year we have created a statistical shape model of the complete shoulder joint including scapula, humerus and clavicle.

Statistical Shape Model of Human Shoulder Joint

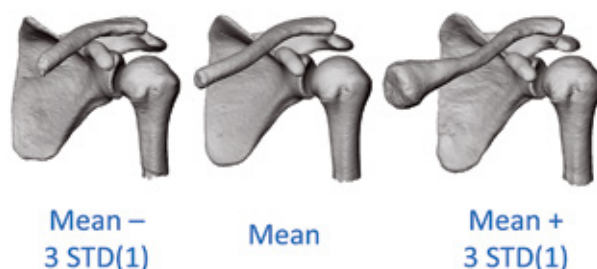

Variations along the first eigen-direction of the statistical shape model of the shoulder joint.

Selected Publications

Murphy WS, Klingenstein G, Murphy SB, Zheng G (2012) Pelvic tilt is minimally changed by total hip arthroplasty. *Clin. Orthop. Relat. Res.* 471(2):417 – 421

Schumann S, Nolte L-P, Zheng G (2012) Determination of pelvic orientation from sparse ultrasound data for THA operated in the lateral position. *Int. J. Med. Robot.* 8(1):107 – 113

Zheng G, von Recum J, Nolte L-P, Grützner PA, Steppacher SD, Franke J (2012) Validation of a statistical shape model-based 2D/3D reconstruction method for determination of cup orientation after THA. *Int. J. Comput Assist Radiol Surg.* 7(2):225 – 231

Schumann S, Nolte L-P, Zheng G (2012) Compensation of sound speed deviation in 3-D B-mode ultrasound for intraoperative determination of the anterior pelvic plane. *IEEE Trans. Inf. Technol. Biomed.* 16(1):88 – 97

Xie W, Schumann S, Franke J, Grützner PA, Nolte L-P, Zheng G (2012) Finding deformable shapes by correspondence-free instantiation and registration of statistical shape model. *MLMI 2012 Springer LNCS 7588: 258 – 265*

Schumann S, Tannast M, Bergmann M, Thali M, Nolte L-P, Zheng G (2012) A hierarchical strategy for reconstruction of 3D acetabular surface models from 2D calibrated X-ray images. *IPCAI 2012, Springer LNCS 7330:74 – 83*

Schumann S, Dong X, Puls M, Nolte L-P, Zheng G (2012) Calibration of C-arm for orthopaedic interventions via statistical model-based distortion correction and robust phantom detection. *ISBI 2012: 1204 – 1207*

de Oliveira ME, Hasler C-C, Zheng G, Studer D, Schneider J, Büchler P (2012) A multi-criteria decision support for optimal instrumentation in scoliosis spine surgery. *Struct Multidisc Optim.* 45:917-929

Franke J, Zheng G, Wendl K, Grützner PA, von Recum J (2012) Clinical experience with computer navigation in revision total hip arthroplasty. *J Engineering in Medicine*, 226(12): 919-926

Patent

Zheng G and Schumann S. Method and device for calibration of X-ray images. European Patent Application No. EP12166279, May 01, 2012.

Medical Image Analysis

Mauricio Reyes, Head of Research Group

Email: mauricio.reyes@istb.unibe.ch

Phone: +41 31 631 59 50

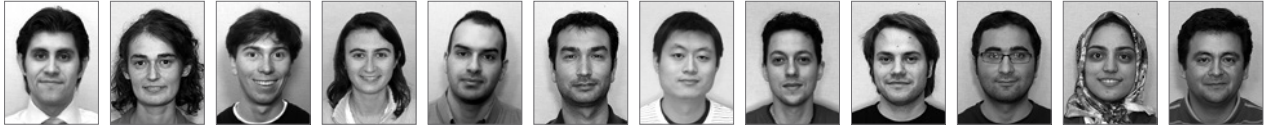

Mauricio Reyes

Livia Barazzetti

Stefan Bauer

Serena Bonaretti

Habib Bou-Sleiman

Arnaud Gelas

Huanxiang Lu

Thiago Oliveira

Christof Seiler

Kamal Shahim

Elham Taghizadeh

Waldo Valenzuela

Research Profile

The Medical Image Analysis group conducts theoretical and applied research in image processing, computer vision, and artificial intelligence for the analysis of medical image datasets. The focus of our research relies on the paradigm of **evidence-based image modeling and personalized medicine**, which aims on the one hand to understand the natural anatomical and physiological variability encountered in a population and, on the other hand, to use this understanding to overcome imaging limitations hindering patient treatment.

During the last year our group has focused on three major questions that align with the paradigm of evidence-based modeling and personalized-medicine:

- How to effectively encompass anatomical and physiological variability for the understanding of musculo-skeletal diseases, the design of orthopaedic devices, and less-invasive, yet more effective orthopaedic surgical approaches?
- How to design planning and post-operative simulation algorithms and systems to assist plastic and cranio-maxillofacial surgeons?
- How to effectively combine Magnetic Resonance Imaging information for a comprehensive spatial and temporal characterization of brain tumors?

Computational Anatomy for Orthopaedic Research

Computational anatomy enables analysis of biological variability throughout a population. Using statistical mathematical techniques models can be built to represent the typical shape of an anatomical structure and its predominant patterns of variability across a given population. During 2012 we have used these techniques to propose population-based implant design for mandibular plates, where bone shape and bone mineral density are considered into a single optimization process. Additionally, we have extended our developments on models that are able to capture the variability of bone shapes using shape descriptors directly related to the clinical application (e.g. mandible fracture) and the existing knowledge of the clinicians about the anatomy (i.e. mandible regions). This facilitates the conjunction of mathematical constructs and the clinical problem at hand.

Oral and Cranio-Maxillofacial Surgery

Our group develops algorithms and systems to perform prediction of soft-tissue deformations after cranio-maxillofacial surgery. The method has been developed with a strong emphasis on its clinical usability (i.e. compliance to imaging protocol, computation speed and usability). The simulation framework features high accuracy by

incorporating non-homogeneous and anisotropic tissue properties as well as sliding contact considerations. During 2012, through a collaboration with partners from the NCCR project Co-Me, we were able to automate nearly every task of the simulation pipeline by considering a statistical shape model of the skull which encodes surgical planning, mechanical and facial muscle information. This enabled us to reduce the complete processing time from 2 hours to 15 minutes as well as to improve the accuracy of our simulations.

In the area of facial soft tissue surgery, and in collaboration with the spin-off company Crisalix, a web-enabled image-based face reconstruction and surgical simulation system has been developed under the auspice of the KTI technology transfer promotion agency. During 2012 the first beta version has been considerably improved, featuring an easy-to-use and accurate web-enabled face reconstruction system from patient photographs.

Brain Image Analysis

Magnetic Resonance Imaging (MRI) and its variants are a powerful imaging modality that encompasses rich

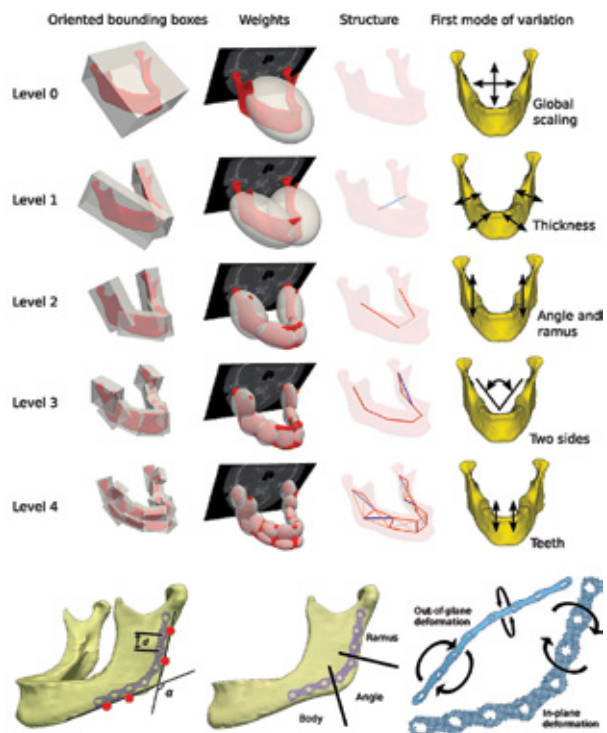

Using computational anatomy to create models aligning with clinical know-how and its application to the design of mandibular implants.

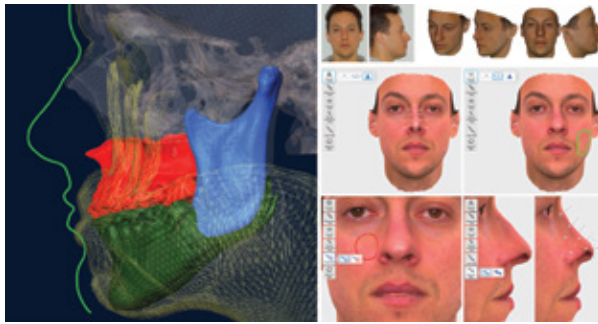

Left: Post-operative prediction of soft tissue deformations for CMF surgery. Right: From photographs to 3D planning of aesthetic facial surgeries.

anatomical and physiological information at a high resolution. In neurosciences these modalities have become a standard in clinical practice. However the interpretation of the images requires the combined use of different modalities, which leads to the need of computer-assisted technologies. The group has developed several methodologies to analyze MRI images with focus on fast multimodal non-rigid image registration and multimodal image segmentation for brain image tumor analysis studies. These developments are driven by clinical requirements such as computation speed, robustness, and use of standard clinical imaging protocols.

During 2012, we tested our previously developed fast multimodal non-rigid registration algorithm on high-field (7 Tesla) MR images obtaining promising results for the correction of EPI distortion in fMRI.

In brain tumor image analysis, we have further developed algorithms to automatically segment glioblastomas grade III and IV from multimodal images (i.e. T1, T1c, T2, FLAIR). The algorithms are based on supervised and unsupervised classification techniques tailored to the clinical scenario. Through this research, our group was awarded the 2nd prize in the international competition for brain tumor segmentation, held at Miccai 2012, Nice, France.

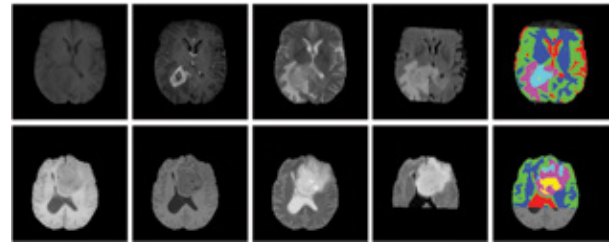

Two example cases (row one and two) of automatic multimodal brain tumor segmentation (input: column 1 to 4, output: last column comprising healthy and tumor compartments) for a comprehensive volumetric analysis of brain tumor assessment.

Selected Publications

Bou Sleiman H, Iizuka T, Nolte LP, Reyes M (2013) Population-Based Design of Mandibular Fixation Plates with Bone Quality and Morphology Considerations. *Ann Biomed Eng.* 41(2):377-384

Seiler C, Pennec X, Nolte LP, Reyes M (2012) Capturing the Multiscale Anatomical Shape Variability with Polyaffine Transformation Trees. *Med Image Anal.* 16(7): 1371-1384

Bauer S, Ritacco LE, Boesch C, Nolte LP, Reyes M (2012) Automatic Scan Planning for Magnetic Resonance Imaging of the Knee Joint. *Ann Biomed Eng.* 40(9):2033-2042

Blanc R, Seiler C, Székely G, Nolte LP, Reyes M (2012) Statistical Model Based Shape Prediction from a Combination of Direct Observations and Various Surrogates: Application to Orthopaedic Research. *Med Image Anal.* 16(6):1156-1166

Seiler C, Gazdhar A, Reyes M, Benneker LM, Geiser T, Siebenrock KA, Gantenbein-Ritter B (2012) Time-Lapse Microscopy and Classification of 2D Human Mesenchymal Stem Cells Based on Cell Shape Picks Up Myogenic from Osteogenic and Adipogenic Differentiation *J Tissue Eng Regen Med.* DOI: 10.1002/term.1575

Ritacco LE, Seiler C, and Farfalli GL, Nolte L, Reyes M, Muscolo DL, Tino LA (2012) Validity of an automatic measure protocol in distal femur for allograft selection from a three-dimensional virtual bone bank system. *Cell Tissue Bank* 1:1-8

Schulz AP, Reimers N, Wipf F, Vallotton M, Bonaretti S, Kozic N, Reyes M, Kienast BJ (2012) Evidence Based Development of a Novel Lateral Fibula Plate (VariAx Fibula) Using a Real CT Bone Data Based Optimization Process During Device Development. *Open Orthop. J.* 6:1-7

Lu H, Nolte LP, Reyes M (2012) Interest points localization for brain image using landmark-annotated atlas. *Int J Imag Syst Tech.* 22(2):145-152

de Heras Ciechowski P, Constantinescu M, Garcia J, Olariu R, Dindoyal I, Le Huu S, Reyes M (2012) Development and Implementation of a Web-Enabled 3D Consultation Tool for Breast Augmentation Surgery Based on 3D-Image Reconstruction of 2D Pictures. *J Med Internet Res.* 14(1):e21

Musculoskeletal Biomechanics

Philippe Zysset, Head of Research Group
 Email: philippe.zysset@istb.unibe.ch
 Phone: +41 31 631 59 25

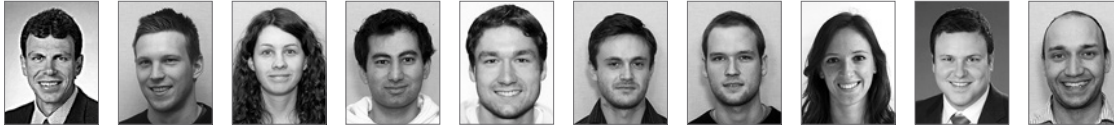

Philippe Zysset Alexander Bürki Allison Clouthier Hadi Hosseini Marc Laurent Ghislain Maquer Jakob Schwiedrzik Tiziana Spampatti Thomas Vizer Uwe Wolfram

Research Profile

The Orthopaedic Biomechanics Group completed the transition related to the appointment of Prof. Philippe Zysset in the Fall of 2011. With the efficient support of the ISTB and the university and canton of Bern a novel biomechanics laboratory was inaugurated in early June 2012 in the presence of colleagues and partners. The equipment of the tissue preparation room was extended, the servo-hydraulic material testing system was moved to the basement and a state-of-the-art depth-sensing nanoindentation system was installed to investigate the post-yield properties of bone extracellular matrix. All the lab procedures for storage, preparation and testing of human and animal tissue were successfully updated. Motivated by the prevention, diagnosis, treatment and follow-up of bone fractures, the research of the group focuses on multi-scale structure-function relationships of bone tissue from the extracellular matrix to the organ level. A combined theoretical, experimental, and numerical approach is pursued to model, validate and simulate the mechanical behavior of human bone in the course of growth, aging, disease and treatment. Research interests range from the elucidation of lamellar bone theory up to failure mechanisms of the proximal femur.

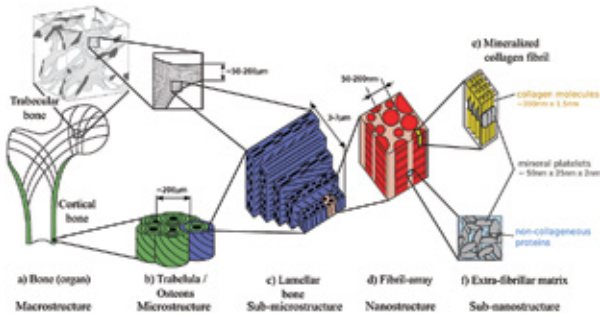

The hierarchical organization of bone (Courtesy of A. Reisinger and P. Varga).

Bone Indentation

Motivated by the implications of metabolic bone diseases and their effects on bone fragility, this research investigated the material properties of bone extracellular matrix (ECM). The experimental method of indentation at the micrometer or nanometer scale represents a powerful method to quantify elastic and post-yield material properties with a high spatial resolution and in various directions. On the experimental side, efforts were directed towards standardization of sample preparation, establishment of

continuous stiffness measurements and testing under wet physiological conditions. On the computational side, a phenomenological constitutive model for bone ECM including the simultaneous viscous flow of plastic strain and reduction in elastic modulus was developed. A generalized yield criterion was formulated to cover a broad range of plastic and damage behavior and open the perspective of an inverse method to identify the post-yield properties of bone with a virtual indentation using finite element analysis. For this purpose, an existing mesh was improved and validated to model a conical or spherical tip indenting bone tissue along axial and transverse orientations with typical depths selected in the experiments.

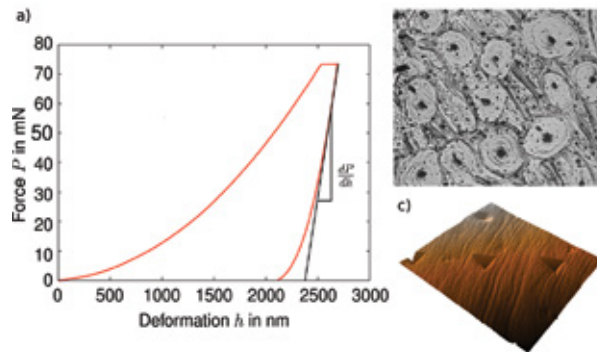

Nanoindentation is used to quantify the mechanical properties of the bone extracellular matrix and decipher the notion of bone quality.

Bone Damage

The risk of undergoing a fracture due to trauma may be increased by previous damage, i.e. nano- and micro-cracks initiated and accumulated under repeated physiological loading conditions. Accordingly, this research aimed at

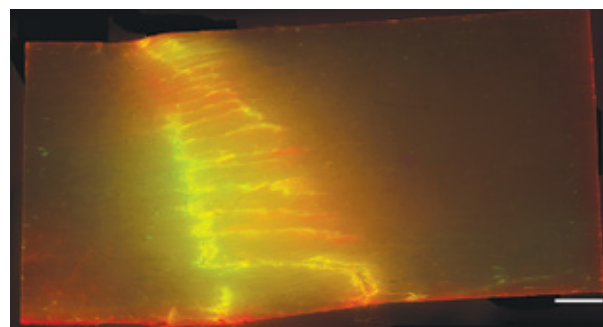

Progressive damage accumulation in compact bone subjected to bending.

exploring the loading mode dependent damage accumulation in bone tissue and its role in femoral fracture risk. An experimental program was designed and launched to visualize and quantify the damage interaction mechanisms along different loading modes. Fluorescence microscopy and high-resolution synchrotron computer tomography protocols were tested to examine the morphology of nano- and micro-cracks in tension, compression and shear of bone tissue. A constitutive model including plasticity and damage that accounts for distinct damage in tension and compression as well as kinematic hardening was formulated and successfully implemented in a mathematical programming environment.

Spine Research

Within the Marie Curie Initial Training Network SpineFX of the European Community this research aimed at improving our understanding of vertebral fracture progression and the biomechanical implications of intervertebral disc degeneration.

For vertebral fracture progression, a novel finite element approach was implemented with the help of our partners from the Prague Technical University to quantify damage accumulation in a non-local fashion. This implies that the resulting finite element simulation of damage accumulation with the existing constitutive model for large strain compression of trabecular bone is not sensitive to the mesh size. This new approach could be applied to simulate compression of trabecular biopsies and vertebral bodies loaded up to 80% strain in a HR-pQCT scanner. For the assessment of disc degeneration, biomechanical tests of a collection of human thoracolumbar spinal segments were conducted to measure their quasi-static compliance in flexion-extension, lateral bending, axial torsion

and compression. In cooperation with the department of clinical research at Bern University, all segments were imaged by magnetic resonance imaging (MRI) with T1 and T2* sequences and graded by two independent spine surgeons. Potential correlations between the clinical grades, MRI images and stiffness were systematically analyzed.

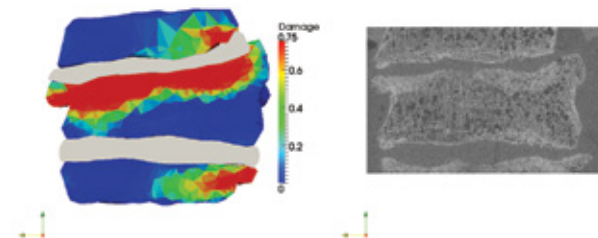

A non-linear finite element model for simulation of vertebral fracture progression.

Biomechanical Testing

Thanks to the updated laboratory, several biomechanical testing projects could already be realized for the benefit of industrial and clinical partners. For instance, the stability of a novel intervertebral cage for fusion of the canine cervical spine designed by the Vetsuisse faculty was evaluated in 4-point bending on a servo-hydraulic testing system. As another example, QCT-based finite element analyses of the L1 & L2 vertebral bodies and the proximal femur of postmenopausal women recruited in a prospective clinical fracture study were delivered to evaluate the efficacy of a novel anti-resorptive treatment for osteoporosis in cooperation with the Vienna University of Technology.

Selected Publications

Chevalier Y, Zysset PK (2012) A patient-specific computer tomography-based finite element methodology to calculate the six dimensional stiffness matrix of human vertebral bodies. *J Biomech Eng.* 134(5):051006

Dall'Ara E, Schmidt R, Zysset PK (2012) Microindentation can discriminate between damaged and intact human bone tissue. *Bone.* 50(4):925-929

Hosseini HS, Pahr DH, Zysset PK (2012) Modeling and experimental validation of trabecular bone damage, softening and densification under large compressive strains. *J Mech Behav Biomed Mater.* 15:93-102

Kinzl M, Benneker L, Boger A, Zysset PK, Pahr DH (2012) The effect of standard and low-modulus cement augmentation on the stiffness, strength, and endplate pressure distribution in vertebroplasty. *Eur Spine J.* 21(5):920-929

Gross T, Pahr D, Peyrin F, Zysset PK (2012) Mineral heterogeneity has a minor influence on the apparent elastic properties of human cancellous bone: A SR μ CT based finite element study. *Comput Methods Biomech Biomed Engin.* 15(11):1137-1144

Maquer G, Dall'Ara E, Zysset PK (2012) Removal of the cortical endplates has little effect on ultimate load and damage distribution in QCT-based voxel models of human lumbar vertebrae under axial compression. *J Biomech.* 45(9):1733-1738

Spiesz EM, Roschger P, Zysset PK (2012) Influence of mineralization and microporosity on tissue elasticity: experimental and numerical investigation on mineralized turkey leg tendons. *Calcif Tissue Int.* 90(4):319-329

Wolfram U, Gross T, Pahr DH, Schwiedrzik JJ, Wilke HJ, Zysset PK (2012) Fabric-based Tsai-Wu yield criteria for vertebral trabecular bone in stress and strain space. *J Mech Behav Biomed Mater.* 15:218-228

Tissue & Organ Mechanobiology

Benjamin Gantenbein, Head of Research Group

Email: benjamin.gantenbein@istb.unibe.ch

Phone: +41 31 631 59 51

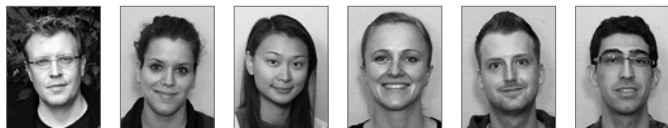

Benjamin Gantenbein

Elena Calandriello

Samantha Chan

Tina Furtwängler

Christian Bucher

Mohammad Javad Shamsollahi

Research Profile

The Tissue & Organ Mechanobiology (TOM) Group of the Institute for Surgical Technology and Biomechanics (ISTB), University of Bern, is performing basic research in the area of tissue engineering using a cross-disciplinary approach of biology and mechanics. The group was previously affiliated within the umbrella of the ARTORG Center from 2008-2012 and is now continued under the framework of the ISTB. Our primary aim is to understand the cellular response to biomechanical stimuli and how cellular communities are affected in situ using 3D tissue and organ culture models. We currently investigate using in vitro culture using large animal intervertebral discs (IVDs). However, we may use any tissue of the muscular skeletal system as model system such as tendons or ligaments. The design of a new bioreactor to culture IVDs has been evolved through collaborative efforts with Jochen Walser and Stephen Ferguson (both at the Institute for Biomechanics, ETH Zürich) to culture live 3D tissue of IVD.

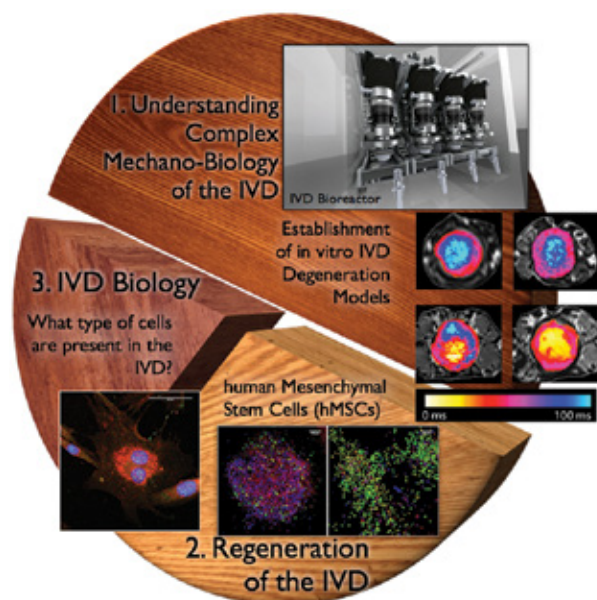

Major research foci of the Tissue and Organ Mechanobiology group.

A strong focus of the TOM group is to develop in vitro intervertebral disc degeneration models, which match closely the human situation using coccygeal IVDs from the cattle. A further focus is how IVDs can be regenerated and how adult human mesenchymal stem cells can be applied on the patient's bedside.

Complex Loading of the Intervertebral Disc

The main focus of this SNF-funded project was to look at the biological response of the IVD under dynamic torsion and compression loading (Jan 2009 - Dec 2012). The initial aim of this project was to look into the effects of compression and torsion onto the metabolism of intervertebral discs, and then to generate a model of disc degeneration by applying hyper-physiological complex loading consisting of dynamic torsion and compression. The SNF project was very successful and future research is planned to focus on the importance of resting in loading regimes and the importance of torsion and biology which seemed generally overlooked in the biomechanical literature. Our recently proposed disc degeneration model can be used to investigate the importance of resting and how torque may cause cell death in the center of the disc.

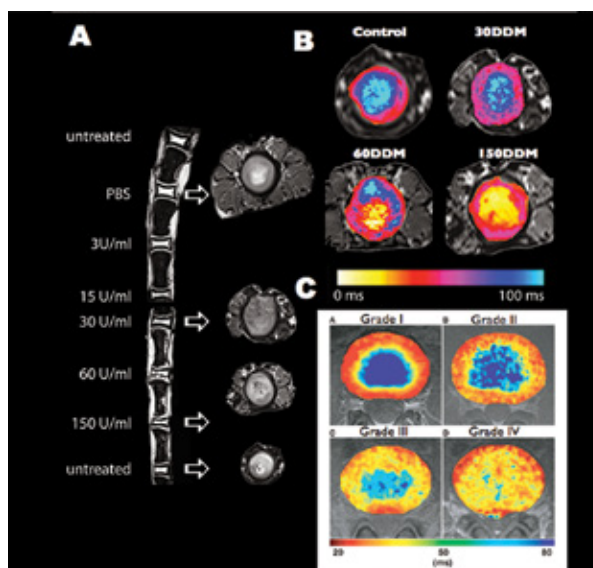

Magnetic resonance (MR) image of a bovine tail injected with various concentrations of papain and a untreated control - A: Anatomical appearance of the whole tail. B: T2* weighted images of 4 concentrations of papain. C: Analogy to disc degeneration grading I, II, III, IV according to Watanabe et al. (2007) AJR Am J Roentgenol 189: 936-942.

Regeneration of the Nucleus Pulposus using "smart" Hydrogels

For this study, which was funded by the Hansjörg Wyss start-up award, a papain-degeneration model, which creates a cavity in the center of the IVD has been developed by our group. In the cavity a thermo-reversible polyamide [poly(N-isopropylacrylamide), pNIPAM, developed and patented by David Eglin and colleagues at the

AO Research Institute along with human mesenchymal stem cells for nucleus pulposus (NP) regeneration has been tested. This start-up project revealed that injected stem cells can indeed survive in this cell-friendly hydrogel and started to differentiate towards IVD precursor cells after 7 days of loading. However, MRI T2* mapping and mechanical tests demonstrated that the mechanical sustainability of NP replacement hydrogels would need to be improved for the long term.

MRI T2* mapping of transverse sections of a pNIPAM thermo-reversible hydrogel injected into 4 bovine coccygeal intervertebral discs in static culture under compressive loading for 7 days (day 9 = prior static loading, day 16 = after static loading). Color-coding can be interpreted as high water content in blue and less water content in orange-red (PDD = papain disc degeneration model, PBS = phosphate buffered saline, TR-HG = thermo-reversible hydrogel, hMSCs = human mesenchymal stem cells, NPC = nucleus pulposus cell).

Investigation of the Regenerative Effects of porcine Notochordal Cells onto bovine Intervertebral Disc Cells under Co-culture

Notochordal Cells (NC) originate from the embryonic notochord, which organizes the embryo during development before establishment of the vertebrae and the spine. The cells disappear in human in the childhood, whereas in other mammals (e.g. mice, rats, pigs), these cells persist throughout their lifetime at high numbers. Most recently, these cells have been shown to have a regenerative potential onto other intervertebral disc (IVD) cells. We found that - even under non-optimized isolation and culture conditions - these cells have a strong potential to activate nucleus pulposus (NP) cells (i.e. the cells from the center of the disc) indeed in a rather short culture period of 14 days, but the mechanisms are still unknown. This project is funded by a Mäxi Grant from the Center of Applied Biotechnology and Molecular Medicine, University of Zürich.

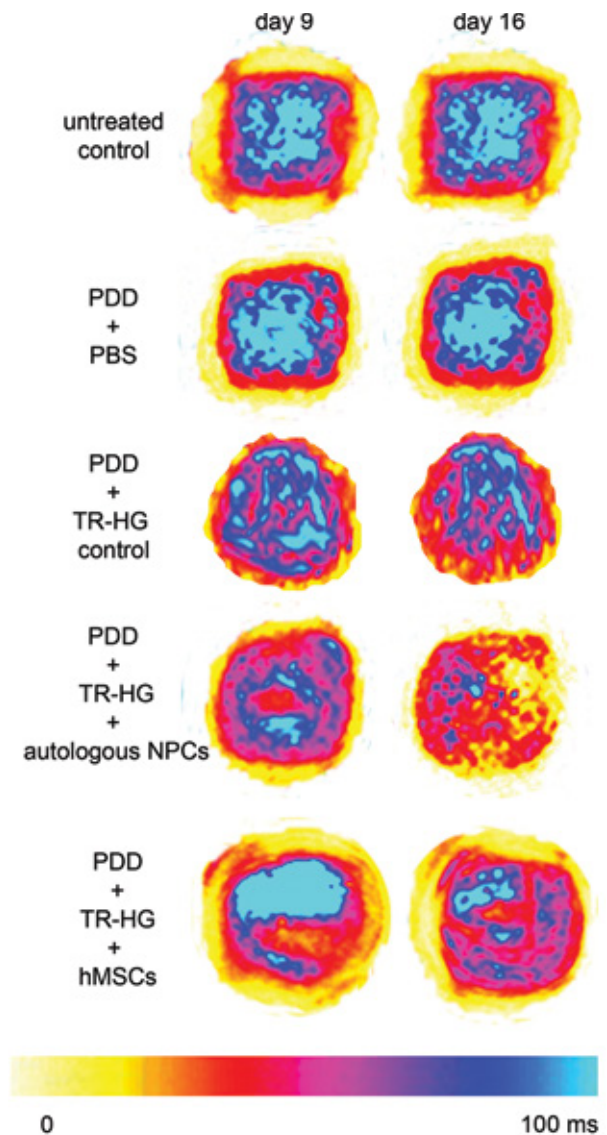

Selected Publications

Chan SCW, Gantenbein-Ritter B (2012) Intervertebral disc regeneration or repair with biomaterials and stem cell therapy - feasible or fiction? *Swiss Med Wkly.* 142: w13598.

Chan SCW, Gantenbein-Ritter B (2012) Preparation of Intact Bovine Tail Intervertebral Discs for Organ Culture *J Vis Exp.* 60(60): e3490.

Seiler C, Gazdhar A, Reyes M, Benneker LM, Geiser T, Siebenrock KA, Gantenbein-Ritter B (2012) Time-lapse microscopy and classification of 2D human mesenchymal stem cells based on cell shape picks up myogenic from osteogenic and adipogenic differentiation, *J Tissue Eng Regen Med* [epub ahead of print].

Steiner TH, Bürki A, Ferguson SJ, Gantenbein-Ritter B (2012) Stochastic amplitude-modulated stretching of rabbit flexor digitorum profundus tendons reduces stiffness compared to cyclic loading but does not affect tenocyte metabolism, *BMC Musculoskelet Disord* 13(1): 222.

Walser J, Ferguson SJ, Gantenbein-Ritter B (2012) Design of a mechanical loading device to Culture intact Bovine Caudal Motional Segments of the Spine under Twisting Motion, In *Replacing animal models: a practical guide to creating and using biomimetic alternatives:* 89-105. Davies, J. (Eds.). Chichester, UK: John Wiley & Sons, Ltd.

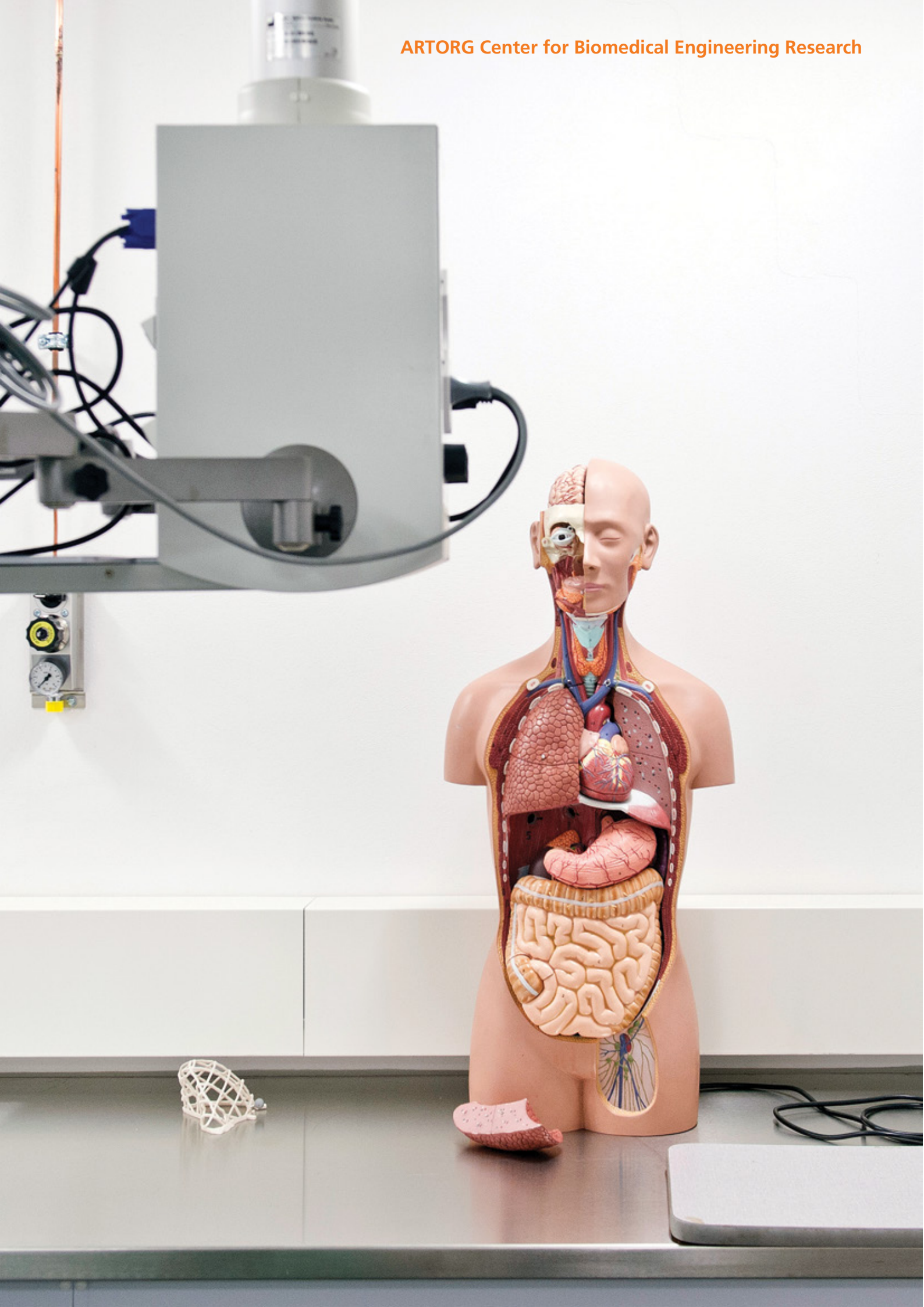

ORGANIZATION

ARTORG Center for Biomedical Engineering Research

Management



S. Weber
Director



L. P. Nolte
Director (until March 2012)



M. Caversaccio
Vice Director

Central Services



M. Steiger
Administration



R. Anniés
IT-Support

Scientific Advisory Board



P. Diem
Director of Division Endocrinology, Diabetes
and Clinical Nutrition
Inselspital, Bern University Hospital



A. Dommann
Vice President CSEM
Program Manager for MEMS
CTI Expert Micro- and Nanotechnology



M. Frenz
Head of Division Biomedical Photonics
Director of Institute for Applied Physics
University of Bern



C. Müller
Head of Division of Experimental Pathology
Vice Dean of Studies: Bachelor in Medicine
University of Bern



A. Raabe
Director and Chairman Department of
Neurosurgery
Inselspital, Bern University Hospital



G. Székely
Director Computer Vision Laboratory, ETH Zurich
Director NCCR CO-ME



H. J. Zweifel
Member of CTI-Expert Team Life Sciences

ORGANIZATION

Research Units

Artificial Hearing Research



M. Caversaccio
Director of ENT, Head and Neck Surgery
Inselspital, Bern University Hospital



C. Stieger
Group Head / External Advisor

Artificial Kidney Research



J. Czerwinska
Group Head



B. Vogt
Chairman Department of Nephrology and
Hypertension
Inselspital, Bern University Hospital



F. Frey
Chairman Department of Nephrology and
Hypertension
Inselspital, Bern University Hospital



D. Uehlinger
Chief Physician Department of Nephrology and
Hypertension
Inselspital, Bern University Hospital

Cardiovascular Engineering



M. Jonsson
Group Head



S. Vandenberghe
Group Head



R. Vogel
Group Head / External Advisor



T. Carrel
Director Department of Cardiovascular Surgery
Inselspital, Bern University Hospital



B. Meier
Director Department of Cardiology
Inselspital, Bern University Hospital

Chair for Image Guided Therapy Center for Computer Assisted Surgery



S. Weber
Group Head



D. Aebersold
Director and Head of Department Radiation
Oncology
Inselspital, Bern University Hospital



D. Candinas
Director and Head of Department Visceral
Surgery and Medicine
Inselspital, Bern University Hospital



M. Caversaccio
Co-Director and Clinical Partner
Director of ENT, Head and Neck Surgery
Inselspital, Bern University Hospital



J. Gralla
Consultant Neuroradiologist, Institute of Diagnostic
and Interventional Neuroradiology
Inselspital, Bern University Hospital



J. Heverhagen
Director and Head of Department of Diagnostic,
Interventional and Pediatric Radiology
Inselspital, Bern University Hospital



J. Kettenbach
Chief Physician, Interventional Radiology (EBIR)
Inselspital, Bern University Hospital



T. Krause
Director and Head of Department Nuclear Medicine
Inselspital, Bern University Hospital

Chair for Image Guided Therapy Center for Computer Assisted Surgery Continued



P. Manser
Head of Division of Medical Radiation Physics
Inselspital, Bern University Hospital



L. P. Nolte
Director of Institute of Surgical Technology
and Biomechanics
University of Bern



A. Raabe
Director and Chairman Department of Neurosurgery
Inselspital, Bern University Hospital



G. Schroth
Director of Institute of Diagnostic and Interventional
Neuroradiology
Inselspital, Bern University Hospital



G. Thalmann
Director and Chairman Department of Urology
Inselspital, Bern University Hospital

Diabetes Technology Research



S. Mougiakakou
Group Head



P. Diem
Director of Division Endocrinology, Diabetes and
Clinical Nutrition
Inselspital, Bern University Hospital

Ophthalmic Technology



J. H. Kowal
Group Head



S. Wolf
Director of Department Ophthalmology
Inselspital, Bern University Hospital

Lung Regeneration Technologies



O. Guenat
Group Head



T. Geiser
Director Division of Pulmonary Medicine
Inselspital, Bern University Hospital



R. Schmid
Director Division of General Thoracic Surgery
Inselspital, Bern University Hospital



M. Gugger
Head Non-Invasive Ventilatory Care
Division of Pulmonary Medicine
Inselspital, Bern University Hospital

Gerontechnology and Rehabilitation



T. Nef
Group Head



U. Mosimann
Department of Old Age Psychiatry
University Hospital of Psychiatry, University of Bern



R. Müri
Division of Cognitive and Restorative Neurology
Inselspital, Bern University Hospital

Tissue & Organ Mechanobiology (ISTB)



B. Gantenbein
Group Head



L. Benekker
Spine Surgeon, Department Orthopaedic Surgery
Inselspital, Bern University Hospital



K. A. Siebenrock
Director of Department Orthopaedic Surgery
Inselspital, Bern University Hospital

Artificial Hearing Research

Marco Caversaccio

Email: marco.caversaccio@insel.ch

Phone: +41 31 632 76 15



Marco Caversaccio

Nicolas Gerber

Wilhelm Wimmer

J r mie Guignard

Andreas Arnold

Simona Wiedmer

Anja Kurz

Martin Kompis

Lilibeth Salas Brogna

Christof Stieger

Research Profile

The sense of hearing plays an important role in interpersonal relationships, orientation and in danger recognition. In Europe, more than 20% of adults suffer from some form of hearing impairment, ranging from slight loss up to complete deafness. In order to improve hearing loss treatments, the Artificial Hearing Research group aims to optimise the design and functionality of implantable hearing systems, in addition to developing enhanced surgical implantation techniques. Within a multidisciplinary team and in collaboration with industrial and clinical partners, research within the fields of signal processing, sound conduction mechanics, computer assisted surgical planning and minimally invasive surgical techniques, are investigated.

New Fitting Approaches for Bone Anchored Hearing Aids

An osseointegrated bone conduction hearing system (Baha) consists of a retroauricularly implanted titanium fixture, a skin-penetrating abutment, and an externally worn speech processor. Osseointegrated auditory implants are widely used for the treatment of conductive or mixed hearing losses and, more recently, also to alleviate the effects of acoustic head shadow in single sided deafness.

In the past, Baha fitting was limited to potentiometer adjustment. With new speech processors available on the market, fitting options have widened due to the integration of programmable chips that can run specific Baha fitting software. While fitting rules are well established

for conventional hearing aids, little knowledge exists about useful fitting rules for Bahas. It has been reported that conventional hearing aid prescription rules are not adequate for bone conduction hearing aids because they would over amplify sound for the patient.

To date, no systematic audiological investigations of the fitting process, especially the role of compression, have been performed and fitting has been based primarily on experience with very little scientific evidence. Our projects aim to improve the knowledge of fitting Bahas to patients that suffer from conductive or mixed hearing loss. In the past year, two clinical studies, towards an improved understanding of fitting requirements for digital speech processors, have been conducted.

Middle Ear Mechanics

In collaboration with researchers from the University Hospital department of ENT, we are exploring several aspects of the middle-ear mechanics using a cadaveric model. We have conducted measurements of the transmission of vibration from the skull base to the middle and inner ear (bone conduction transmission) using laser interferometry (Fig 1). In order to validate the cadaver head model for middle ear research, mechanical behaviors are being explored. Pathological conditions in the middle ear (such as otosclerosis) and surgical interventions (stapedotomy, stapedectomy, and stapes prosthetics) are being reproduced to test their influence on the conduction of sound through bone conduction.

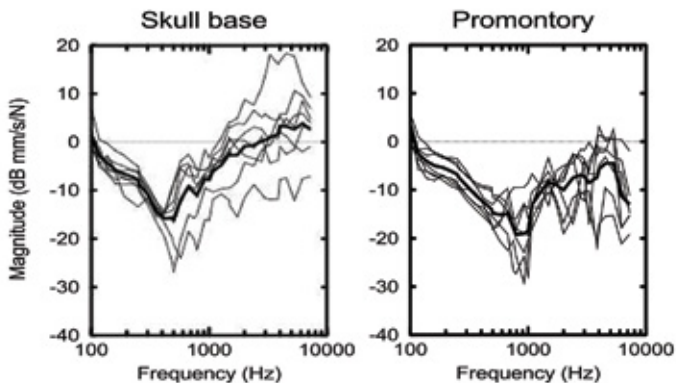
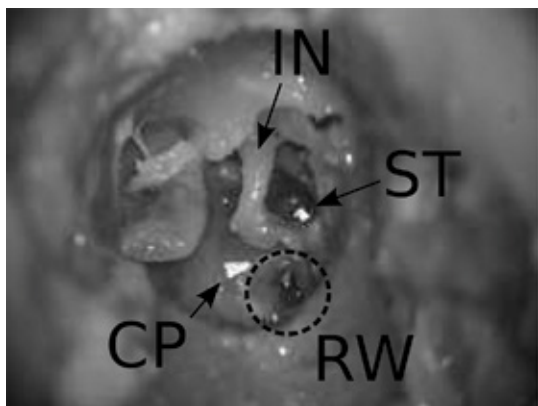

Left: the middle ear is exposed through the elevation of the tympanomeatal flap. IN: incus; ST: stapes; CP: cochlear promontory; RW: round window. Small patches of reflecting tape are used for laser interferometry. Right: the skull base and promontory velocity in 7 cadaver ears, with the thick black line representing the mean.

In addition, we are developing: a method to test a mechanical middle-ear implant in situ using a purely acoustic approach; a computer assisted surgical planning tool for implantations in the temporal bone; and a vascular access port located in the temporal bone in collaboration with the department of nephrology.

Computer Assisted Preoperative Planning for Hearing Aid Implantation

It is hypothesised that, by reducing complexity and improving understanding, computer assisted preoperative planning may aid surgeons in the conduction of hearing aid implantation procedures in cases of malformation and in cases of normal anatomy. To investigate this hypothesis, the efficacy of a custom planning software tool dedicated to patient-specific hearing aid implantation (Fig 2) was validated for use in conventional cochlear implantation surgery, in a prospective single arm clinical pilot study. Within a single institution (Bern University Hospital), computer assisted planning was employed in eight cochlear implantation procedures between August and December 2012. Results of this study suggested that benefits such as

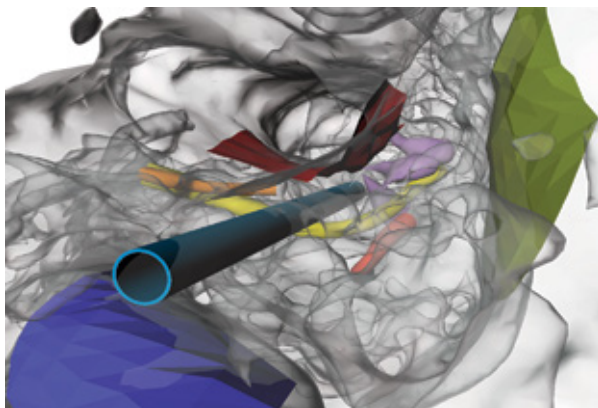

Patient specific plan for a conventional cochlear implantation. Sigmoid sinus wall (dark blue), planned access to the cochlea (light blue tunnel), middle fossa dura (green), external auditory canal (dark red), ossicles (purple), lateral semicircular canal (pink), chorda tympani (orange), facial nerve (yellow).

improved surgical confidence, reduced surgical time and better 3D anatomical understanding may result from the use of the proposed computer assisted planning approach even in routine cases.

Minimally Invasive Cochlear Implantation Surgery

Recent research activities have focused on the reduction of invasiveness for cochlear implant (CI) surgery. A custom image-guided microsurgical robot system, developed within the group for image guided therapy, facilitates the minimally invasive CI approach, the direct cochlear access (DCA), by drilling a small tunnel (1.8 mm in diameter) through the mastoid part of the temporal bone. As the project progresses, a possible first-in-man study is intended to be conducted by the research team. An in-vitro study investigating the feasibility and efficacy of electrode insertion without the aid of insertion tools has been conducted (Fig. 3). Required further investigation into an optimal electrode implantation approach that provides atraumatic insertion when hearing preservation is demanded is currently being undertaken.

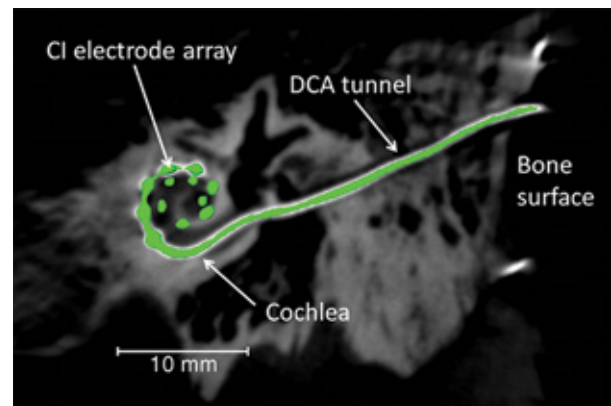

Cone-beam CT scan of a human temporal bone with a minimally invasive implanted CI electrode array (green). The electrode array was advanced through a small DCA tunnel and inserted into the cochlea.

Selected Publications

Bell B, Stieger C, Gerber N, Arnold A, Nauer C, Hamacher V, Kompis M, Nolte LP, Caversaccio M, Weber S (2012) A self-developed and constructed robot for minimally invasive cochlear implantation. *Acta oto-laryngologica*, 132(4) : 355–360

Stieger C, Candreia C, Kompis M, Herrmann G, Pfiffner F, Widmer D, Arnold A (2012) Laser Doppler vibrometric assessment of middle ear motion in Thiel-embalmed heads. *Otology & Neurology*, 33(3) : 311-8

Nauer CB, Zubler C, Weisstanner C, Stieger C, Senn P, Arnold A. (2012) Radiation dose optimization in pediatric temporal bone computed tomography: influence of tube tension on image contrast and image quality. *Neuroradiology*, 54(3) : 247-54

Gerber N, Bell B, Kompis M, Stieger C, Caversaccio M, Weber S (2012) A software tool for preoperative planning of implantable hearing devices. *Int J Comput Assist Radiol Surg*, 1(7) : 134–135

Artificial Kidney Research

Justyna Czerwinska, Head of Research Group

Email: justyna.czerwinska@artorg.unibe.ch

Phone: +41 31 632 75 77



Justyna Czerwinska

Khadija Mrabet

Stefan Wolf

Muluken Terefe

Phillipe Schiessl

Hanieh Mohammadi

Guillaume Deliencourt

Michael Rieger

Clinical partners

Bruno Vogt, Chairman Department of Nephrology and Hypertension

Felix Frey, Chairman Department of Nephrology and Hypertension

Dominik E. Uehlinger, Chief Physician Department of Nephrology and Hypertension

Research Profile

The replacement of failed renal function by dialysis is one of the most successful stories in the field of artificial solid organ replacement. While some patients have survived more than 30 years with dialysis therapy, there are still many unresolved problems; dialysis patients have a highly accelerated mortality rate and the current state-of-the-art in dialysis therapy, while highly effective during the actual treatment procedures, results in an average clearance corresponding to only about 10 to 15% of a normal renal function over a whole week.

Conventional methods to increase dialysis delivery during treatment through increased filter quality or the addition of convective transport have failed to decrease overall mortality in controlled studies. Insufficient data is available about the effectiveness of increased treatment frequency, and when combined with the high cost of hemodialysis procedures it seems unlikely that an increased number of treatments per week is an appropriate solution unless simplification of treatment practices and reduction of costs per treatment can be achieved.

The major goal of our research is to develop micro/nano-fluidic devices which reflect the different functions of the kidney more precisely than current dialysis systems.



Kidney vascular system.

Virtual Kidney

Each year half a million people undergo kidney transplantation from a deceased donor, with demand for organs significantly surpassing the number of donors. One possible solution to this challenge is through the development of an artificial kidney. The kidney can be seen as a complex filtration system which removes toxic substances from the body and retains useful ones; the kidney's basic filtration unit, called a nephron, performs multiple functions such as regulation of salt and water, electrolyte and acid base homeostasis, as well as the elimination of toxins. This project involves the recreation of fundamental kidney functions through computer simulations of complex multiphysical systems. Each function of the nephron is modelled and investigated separately as a system of micro- and nanofluidic channels with the aim of building a virtual microfluidic system capable of simulating the functions of the nephron. In the future such a design can be validated experimentally and tested in clinical trials.

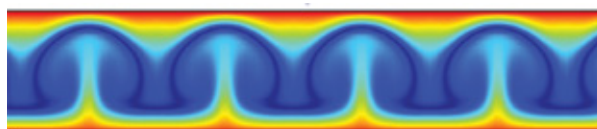

Simulations of the transition to turbulence flow between two rotating cylinders. The scheme presents efficient drug mixing device for medications in a blood.

Optimization of Hemodialysis Process

This project aims to optimize hemodialysis performance by means of numerical analysis. There are two intermediate goals: one is to establish an understanding of blood flow

behavior in hollow fibers under the turbulence transition regime; the other is to study the influence of flow on the separation of particles of various sizes, which are later removed. The results of such analyses can be directly applied to clinical situations. The methodology of the project is based on the usage of the Lattice Boltzmann Method to model the complex properties of fluid such as non-Newtonian effects, charges of the particles and diffusion. First, turbulence transition flows inside the hollow fiber (pipe flow) are modelled with complex multiphysics simulations; these models are then extended into the porous media application and compared with available clinical data.

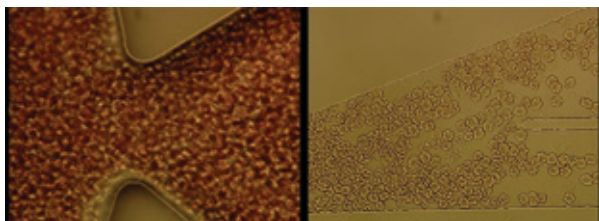

View of the red blood cells on the microchip design for the cell's separation based on the elasto-mechanical properties.

Micro/Nanoparticles in Biological Environments for Patient Assistance Devices

This project involves the investigation of several aspects related to micro/nano particles in biological fluid such as blood or cell cytoplasm, with potential applications for anticoagulation devices and blood analysis systems as well as for the monitoring of the efficiency of delivered dialysis therapy. Monitoring the overall effect of intermittent renal replacement therapy over a prolonged observation period is cumbersome. It is estimated by relating the total amount of uremic toxins removed to the area under their serum concentration curve (AUC) over the whole observation period. Multiple serum samples will have to be obtained during and between treatment sessions to estimate the AUC over a full week with intermittent renal replacement therapy.

Patients completing 3 sessions of 4 hours per week at a dialysis unit are reluctant to spend additional time at the dialysis center between treatments for the additional blood samples necessary to come up with a reliable estimate of treatment efficiency over the whole observation period. Several devices have recently been developed for the continuous sampling of serum levels of various substances, with the most advanced portable devices designed for feedback controlled insulin pumps. We aim instead at simplicity in monitoring. As we are only interested in the area under the serum concentration curve, albeit over a long time period, samples can be collected and results stored for future reading at the hospital. Nevertheless, the proposed device must determine

Selected Publications

Lewandowski T, Ochrymiuk T, Czerwinska J (2012) Modelling of Heat Transfer of Microchannels Gas Flow, ASME J. Heat Transfer 133(2):

Czerwinska J, Jebauer S (2012) Secondary Slip Structures in Heated Micro-geometries, Int. J. Heat Mass Trans. 54(7-8):1578 – 1586

serum levels with a high accuracy due the accumulation of systemic errors when multiple values are added. Such accuracy can only be achieved on a microchip. Initial work will focus on blood urea nitrogen, phosphorus and beta-2 microglobulin.

Lifespan of the Red Blood Cells (RBC)

Many patients with chronic kidney disease (CKD) suffer from anemia, i.e. an insufficient number of circulating RBCs. Renal failure results in a decrease of renal erythropoietin (EPO) production, which is the major stimulus of RBC production in bone marrow, however lower circulating EPO levels explain only part of the observed anemia. In addition to decreased RBC production, an increased RBC elimination is also observed in these patients. The lifespan of RBCs in uremic patients is variably decreased to about one half of the lifespan in patients with normal renal function. In CKD patients undergoing hemodialysis therapy the results are conflicting. While the improvement of the uremic milieu by renal replacement therapy should increase RBC lifespan, the cell might be destroyed by the hemodialysis procedure.

The ageing of RBCs is characterized by several factors including reduction of the elastic modes of the cell membrane, increased membrane stiffness, reduced surface area and volume, increased intracellular density and viscosity and reduced hemoglobin content.

The aim of this project therefore is to study the aging processes of RBC and from subsequently predict the lifespan of individual RBC and RBC cell populations.

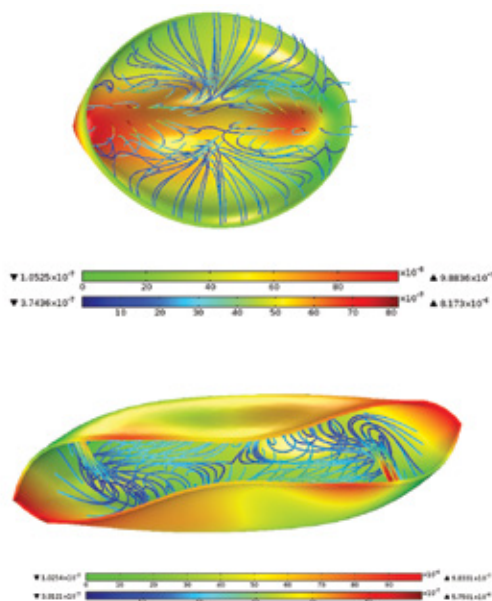

Simulations of a red blood cell stretched by optical tweezers. Figure shows surface displacement and flow streamlines.

Cardiovascular Engineering

Stijn Vandenberghe, Head of Surgery Group, Magnus Jonsson, Head of Cardiology Group
Email: stijn.vandenberghe@artorg.unibe.ch, magnus.jonsson@artorg.unibe.ch
Phone: +41 31 632 75 88

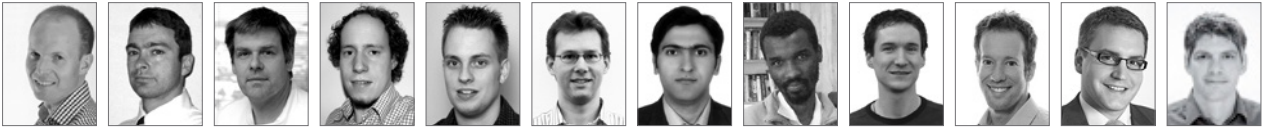

Magnus Jonsson Stijn Vandenberghe Rolf Andreas Häberlin Thomas Niederhauser Alois Pfenniger Tohid Pirbodaghi Thanks Marisa Adrian Zurbuchen Stefan Guggisberg Andreas Mächler Oliver Wüthrich

Clinical Partners

Bernhard Meier, Director Department of Cardiology
Thierry Carrel, Director Department of Cardiovascular Surgery

Research Profile

The Cardiovascular Engineering (CVE) group at the ARTORG Center is a joint technological-clinical research unit, combining expertise in biomedical engineering and clinical research with clinical medicine in search of novel solutions for the diagnostic and therapeutic management of cardiovascular diseases. With the focus firmly on the patient, our dedicated vision is to improve cardiovascular care through education, development, application and evaluation. In order to realize this vision, joint ventures are established and services rendered thereby leading to the continuous translation of new and novel technologies from the lab to clinical practice. Integration into the medical technology industry network within Switzerland and worldwide, as well as the formation of strong relationships with clinical partners, ensures a direct path to the realization of our research goals.

The Esophageal Electrocardiogram

To register heart rhythm disturbances (arrhythmias) with a better signal quality and for a longer duration compared to conventional devices, our group works on an innovative esophageal ECG (eECG) recording system. In collaboration with the Inselspital Bern and the University of Applied Sciences, Biel, we developed several prototypes of this device.

A key challenge was to develop dedicated software allowing for fast analysis of the eECG data. The amount of data is massive, as a continuous recording duration of 30 days is targeted. Such a long recording period is required because arrhythmias are often rarely occurring and short-lasting.

One of our research goals is therefore to limit the eECG signal processing time to guarantee fast analysis of the eECG data. An efficient graphical user interface allows physicians to scroll quickly through the whole recording while the required high computational power can be offered by GPU-based signal processing. To remove eECG signal distortions (baseline wander), different filter meth-

ods were compared. Finally, sensitive beat classification algorithms based on neural networks were developed.

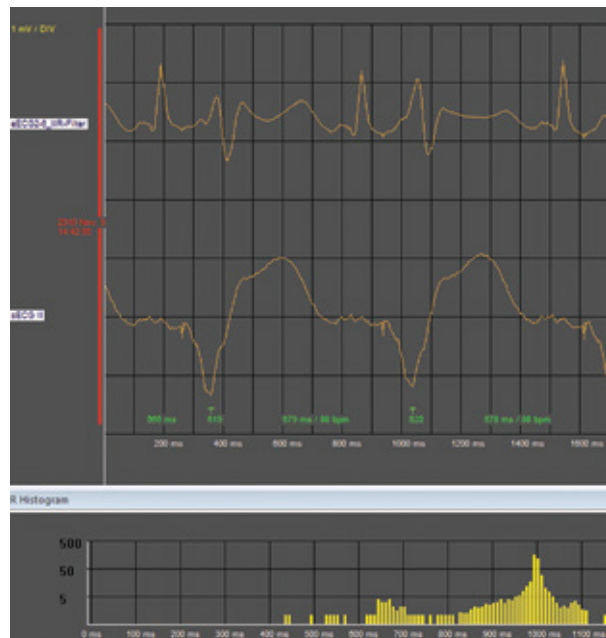

Detailed view of the eECG recording visualization software. Top: the eECG signal can be analyzed in detail. Bottom: several tools help the physician to find relevant arrhythmic episodes.

Energy Harvesting

Power supply is a major restriction in the design of medical implants such as pacemakers, defibrillators and neuro-stimulators. Battery size often dictates the volume of devices and batteries need to be replaced periodically, which leads to repeated interventions. Various energy sources can be found in the human body and its surroundings. The uninterrupted function of the cardiovascular circulation is the focus of our group; we are investigating the feasibility of harvesting hydraulic energy from blood flow, arterial wall deformations as well as the oscillating motion of the heart itself.

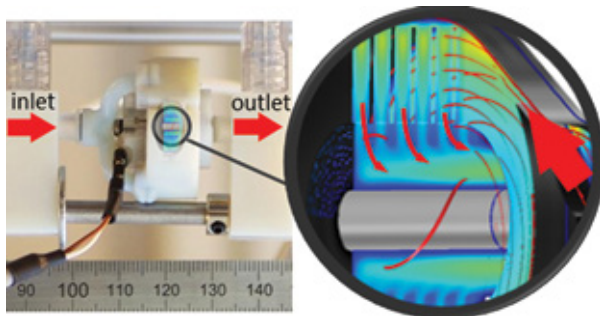

A miniature hydrodynamic turbine generator capable of harvesting 1mW has been built and tested in vitro. Numerical flow simulations are employed to find solutions that minimize blood trauma and clot formation.

Ventricular Load Control

Patients with severe heart failure can be supported with a mechanical blood pump. In some cases it may lead to healing of the patient as the heart can be unloaded and given the chance to 'rest'. It is possible that more patients recover if the load on the heart can be accurately controlled such that a training regime can be executed. We hypothesized that by timed synchronizing of the pump assistance with the heart beat (phase shifting) we can control the work that the heart's Left Ventricular (LV) chamber needs to deliver. A ventricular assist device with modified pneumatic driver has been tested in vivo showing that synchronization leads to more stable loading of the heart than the clinically used fill-empty mode.

PV-loops for different Phase Shifts

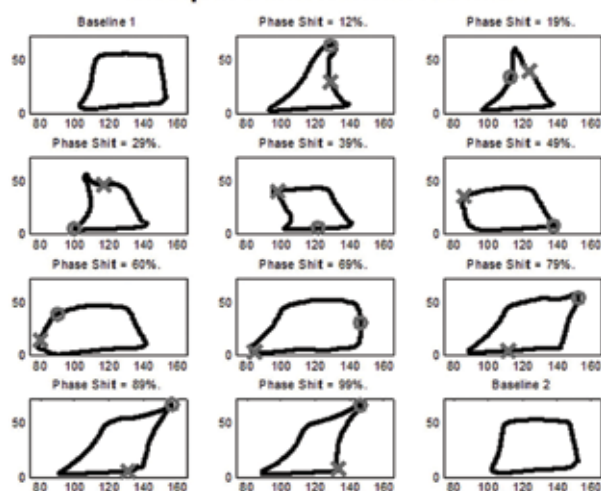

Phase shifting has a significant impact on the pressure and volume (PV-loops) in the LV, and thus on the work of the heart.

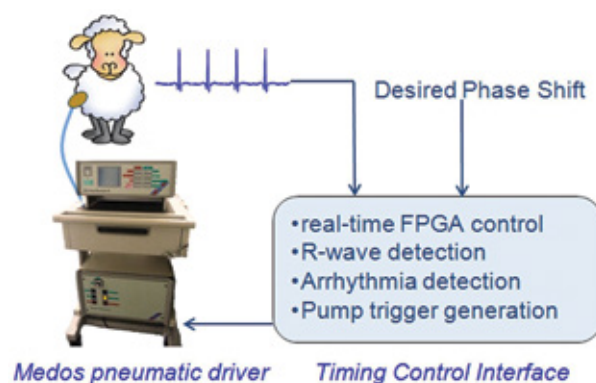

Schematic of the phase shifting to control ventricular load

Selected Publications

Amacher R, Weber A, Brinks H, Axiak S, Ferreira A, Guzzella L, Carrel T, Antaki J, Vandenberghe S (2013) Control of ventricular unloading using an electrocardiogram-synchronized Thoratec paracorporeal ventricular assist device. *J Thorac Cardiovasc Surg* DOI:10.1016/j.jtcvs.2012.12.048 (in press)

Haerberlin A, Niederhauser T, Marisa T, Mattle D, Jacomet M, Goette J, Tanner H, Vogel R (2012) Esophageal long-term ECG reveals paroxysmal atrial fibrillation. *Circulation* 125(18):2281-2282

Haerberlin A, Niederhauser T, Tanner H, Vogel R (2012) Atrial waveform analysis using esophageal long-term electrocardiography reveals atrial ectopic activity. *Clin Res Cardiol* 101(11):941-942

Niederhauser T, Marisa T, Haerberlin A, Goette J, Jacomet M, Vogel R (2012) High-resolution esophageal long-term ECG allows detailed atrial wave morphology analysis in case of atrial ectopic beats. *Med Biol Eng Comput* 50(7):769-772

Pfenniger A, Obrist D, Stahel A, Koch VM, Vogel R (2012) Energy Harvesting through Arterial Wall Deformation: Design Considerations for a Magneto-Hydrodynamic Generator. *Medical & Biological Engineering & Computing* DOI:10.1007/s11517-012-0989-2 (in press)

Pirbodaghi T, Axiak S, Weber A, Gempp T, Vandenberghe S (2012) Pulsatile control of rotary blood pumps: Does the modulation waveform matter? *J Thorac Cardiovasc Surg* 144(4):970-977

Pirbodaghi T, Weber A, Axiak S, Carrel T, Vandenberghe S (2013) Asymmetric speed modulation of a rotary blood pump affects ventricular unloading. *Eur J Cardiothor Surg* 43(2):383-388

Zurbuchen A, Pfenniger A, Stahel A, Stoeck CT, Vandenberghe S, Koch VM, Vogel R (2012) Energy Harvesting from the Beating Heart by a Mass Imbalance Oscillation Generator. *Ann Biomed Eng* 41(1):131-141

Diabetes Technology Research

Stavroula Mouggiakakou, Technical Head of Research Group

Email: stavroula.mouggiakakou@artorg.unibe.ch

Phone: + 41 31 632 75 92



Stavroula Mouggiakakou



Marios Anthimopoulos



Sergey Shevchik



Luca Scarnato



Elena Daskalaki



Joachim Dehais



Thomas Zueger



Manuel Maurer

Clinical Partners

Peter Diem, Director of Division Endocrinology, Diabetes and Clinical Nutrition

Research Profile

The Diabetes Technology Research Group (DTRG) is a collaborative research group of the ARTORG Research Center for Biomedical Engineering Research and the Division of Endocrinology, Diabetes and Clinical Nutrition at the University Hospital of Bern (Inselspital).

Maintaining glucose concentration levels within normoglycemic range is essential for individuals with diabetes mellitus and prevents them from life-threatening events, such as severe hypoglycemia, and long-term complications. New technologies on glucose sensing, insulin delivery, carbohydrate estimation and monitoring of vital signals are needed towards enhanced glycemic control and improved quality of life for many individuals living with diabetes.

DTRG, using biomedical engineering approaches, is performing complex, cutting edge research towards an artificial pancreas. Technologies on simulation and control of physiological systems, machine learning, computer vision, and e-/m-Health solutions are explored in projects related to control of glucose profile, estimation of carbohydrate intake and quantification of glycemic variability. The ultimate goal is the development of an integrated patient-centric computational system which will function as an external artificial pancreas closing the loop between glucose sensors and insulin delivery devices. Furthermore, the usability of the proposed technologies is further investigated in other research areas related to management of chronic diseases.

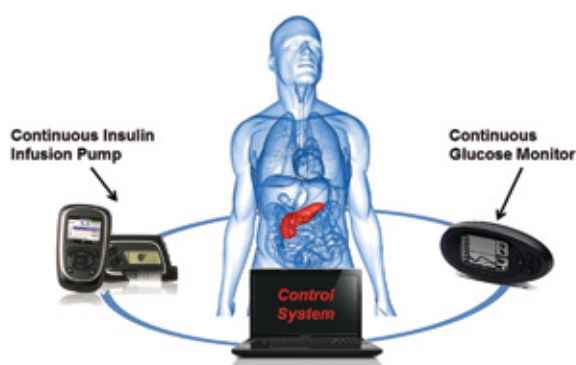

Components of an external artificial pancreas.

Artificial Pancreas

The artificial pancreas has been at the forefront of diabetes research since the 1970s aiming at the replacement of the role of the distorted pancreatic beta-cells by external automatic insulin infusion. The components of the artificial pancreas are a Continuous Glucose Monitor (CGM), a continuous insulin infusion pump and a control system for the estimation of optimal insulin treatment.

Development of Novel Algorithm for Closing the Loop

The aim of this on-going project is the design, development and evaluation, both in silico and in a clinical environment, of a novel control algorithm for the optimal, personalized estimation of insulin infusion, closing the loop between a CGM and insulin pump.

The algorithm, inspired by the principles of reinforcement learning and optimal control, is based on the Actor-Critic learning approach and is being proposed for glucose regulation for the first time. The main advantage is the online adaptive ability in order to handle the high inter-/intra- patient variability occurring from the diversions of insulin sensitivity, physical activity and other environmental factors. The current version of the algorithm has been evaluated in silico in adults, adolescents and children showing significant improvement in glucose regulation compared to standard basal-bolus treatment.

Hypoglycemia Prediction based on Data-Driven Models

Intensive insulin treatment has an inherent risk for undesired metabolic conditions. Data-driven models, based on advanced statistical and computational intelligence methods are developed for the prediction of glucose profile in the near future and the early recognition of upcoming hypo- and hyperglycemic events. The models are personalized and online adaptive in order to capture the inter-/intra- patient variability and enhance the performance and safety of the controller.

So far, real time adaptive models based on auto-regression techniques and artificial intelligence methods have been developed and comparatively assessed using both in silico and real patient data. The models have been combined for the development of an early warning system against hypo- and hyperglycemic events. The results have shown that fusion of regression and artificial intelligence based models achieves prompt and accurate prediction with limited daily false alarms.

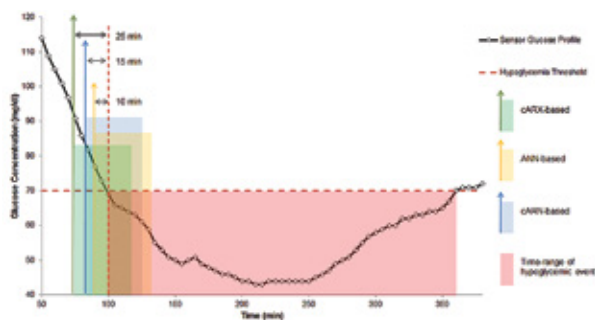

Measured (blue line) and predicted by one model (green line) glucose concentration. Red circle emphasizes the prediction of hypoglycemia.

Carbohydrate Estimation based on Computer Vision

For the estimation of the insulin dose, the diabetic patient needs to measure the pre-meal glucose concentration and to accurately count the carbohydrates (CHO) of the anticipated meal. Imprecise counting of CHO can lead to either under- or overdosing of insulin.

The scope of this EU funded project (www.gocarb.eu) is to design, develop and evaluate a computational system which will help individuals with diabetes to automatically estimate in near real-time the grams of CHO in their meal. In a typical use scenario the individual with diabetes acquires a pair of pictures of the upcoming meal through a mobile phone camera. Initially the dish is localized semi-automatically, and then the image is segmented based on color information so that the different food types are localized and distinguished from each other. Food type recognition follows using both color and

texture features. After classifying the existing food items, those with CHO content are reconstructed in the 3D space in order to estimate their volume as well as their CHO grams. The final and ultimate goal of the system is the calculation of the optimum insulin bolus given the meal's CHO content and patient specific data.

For the food localization, the image is filtered with an edge preserving filter and segmented based on a color clustering technique followed by connected component analysis. Then color histogram and Local Binary Features (LBP) are computed and fed to a Support Vector Machine classifier (SVM) that classifies each of the localized food items into a series of predefined food classes. For the training and evaluation of the system, two visual datasets with a broad spectrum of European meals have been created. The first one consists of 104 meals acquired under controlled conditions while the second one contains over 5000 food images downloaded from the Web under different shooting conditions.

For the food volume estimation, a two-view geometry approach is used. This technique allows getting a shape of an object from a set of images, obtained from different points of view. The data processing includes seven stages and involves a variety of mathematical methods. The main challenges of the 3D reconstruction are the short distances between the camera and the object, and the intense phone camera noise levels.

The performances of each module separately are satisfactory considering the challenges of the problem. Optimization of recognition and 3D reconstruction are in progress, as well as the integration of the various algorithms into a smartphone.

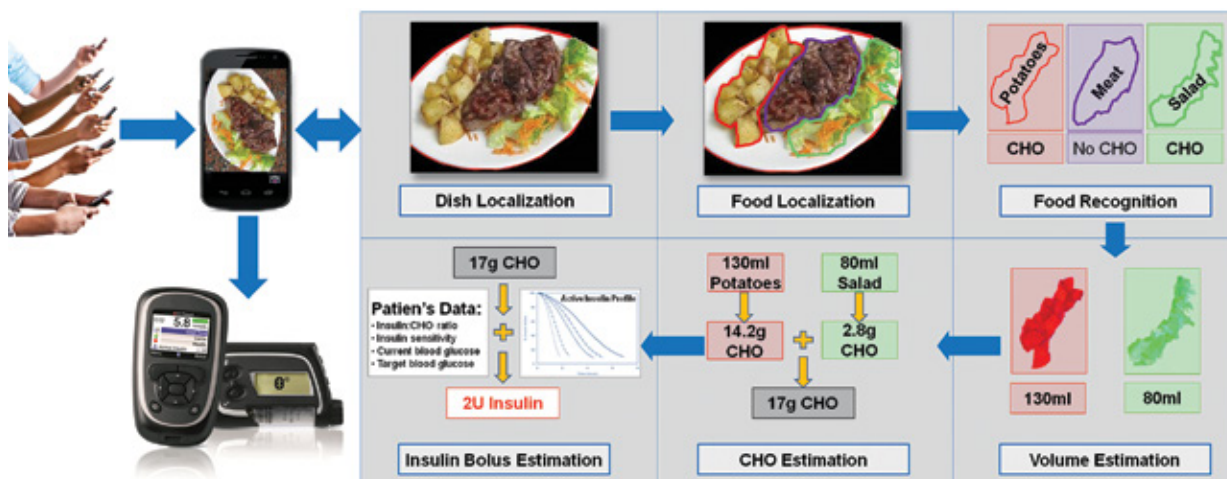

Through a mobile phone application the picture of a meal can be analyzed and the corresponding grams of CHO estimated.

Selected Publications

Daskalaki E, Nørgaard K, Züger T, Proutzou A, Diem P, Mougiakakou S (2013) An Early-Warning System for Hypo-/Hyperglycemic Events Based on Fusion of Adaptive Prediction Models. *J Diabetes Sci Technol*. (In press)

Daskalaki E, Diem P, Mougiakakou S (2013) An Actor-Critic Based Controller for Glucose Regulation in Type 1 Diabetes. *Comput Meth Prog Bio*. 109:116-125

Zueger T, Diem P, Mougiakakou S, Stettler C (2012) Influence of Time Point of Calibration on Accuracy of Continuous Glucose Monitoring in Individuals with Type 1 Diabetes. *Diabetes Technol Ther*. 14(7):583-588

Daskalaki E, Proutzou A, Diem P, Mougiakakou S (2012) Real-Time Models for the Personalized Prediction of Glycemic Profile in Type 1 Diabetes Patients. *Diabetes Technol Ther*. 14(2):167-174

Gerontechnology and Rehabilitation

Tobias Nef, Head of Research Group

Email: tobias.nef@artorg.unibe.ch

Phone: +41 31 632 46 97



Tobias
Nef



Raluca
Ganea



Rahel
Bieri



Nicole
Gruber



Michael
Jäger



Reto
Stucki



Giuseppe
Zito



Jittima
Saengsuwan

Clinical Partners

Urs P. Mosimann, Department of Old Age Psychiatry

Renè Müri, Division of Cognitive and Restorative Neurology

Research Profile

The interdisciplinary Gerontechnology and Rehabilitation Research Group was established in May 2010 as a collaborative research group of the ARTORG Center for Biomedical Engineering Research, the Department of Old Age Psychiatry, and the Division of Cognitive and Restorative Neurology within the medical faculty at the University of Bern. Gerontechnology is the study of technology and aging for the promotion of good health, social participation, and independent living. Rehabilitation embraces the coordinated use of medical, social, professional, and technical means to improve function to allow independent participation in all areas of life with acceptable risks and good quality of life. The relevance of these fields increases with the aging of our society. In this context, the group develops and evaluates assistive and rehabilitative technologies to support elderly and disabled people to enhance autonomy and promote independent living while reducing the risks associated with daily living. Current projects aim to promote independence by enhancing in-home mobility as well as mobility and traffic-participation outdoors.

Furthermore, the group develops new training techniques for strengthening cognitive performance.

Assistive Technology to Enhance Safety and Autonomy of Dementia Patients at Home

Most dementia patients have a strong desire to live autonomously in their known environment as long as possible. This often leads to trade-offs between the patient's desire to live at home and the risks that increase with the progression of the cognitive decline. In combination with existing (i.e. Spitex) and new (i.e. ambulant old-age psychiatry) clinical and social caregiving approaches, assistive technology can play an important role in reducing risks associated with independent living. In this project we develop and evaluate a new assistive technology system that meets the specific needs of elderly patients with cognitive impairment. One key feature of the new system is that it works in the background and it does not require active interaction between the system and the supported patient. It measures environmental data (e.g. light distribution, movement patterns) and uses this information to detect unusual situations (e.g. falls, wandering), to estimate the patient's wellbeing, to assess the patient's ability to cope with activities of daily living, and to predict short- and long-term risks. Currently, the system is undergoing

testing in the homes of healthy test persons to evaluate its ability to recognize activities of daily living. This project is funded in part by the Bangerter-Rhyner Foundation.



Five to ten sensor boxes are positioned in the patient's home to measure environmental data (temperature, light, IR-radiation). The sensors are battery-powered and the data are transferred via radio-communication allowing quick and cable-free installation in the patient's home. The image shows one sensor box positioned in a kitchen of a healthy test person.

The Age-Dependent Effect of Night Driving on Visual Performance and on Simulated Driving Behavior

Both younger and older drivers are challenged by reduced vision in low-light conditions as they occur during night driving. Contributing factors are age-related increased glare sensitivity and decreased mesopic visual acuity. We assume that the visual exploration behavior under mesopic light conditions is an important predictor of driving performance. In this project, the age-dependent influence of mesopic vision, cognition, and comorbidity are evaluated regarding their influence on visual exploration behavior and on simulated driving performance. In collaboration with Haag-Streit AG (Köniz, Switzerland) and with the support of the Haag-Streit Foundation, we are developing a screening tool for the Octopus 900 perimeter that will support and enhance "fitness-to-drive" assessments and decisions. Recently, the new test setup has been evaluated in 120 healthy test persons of all ages. The study revealed significant age-effects in the recognition rate of peripheral targets. Current work focuses on new tests to measure

higher visual functions and on the integration of the new tests into the commercial perimeter.

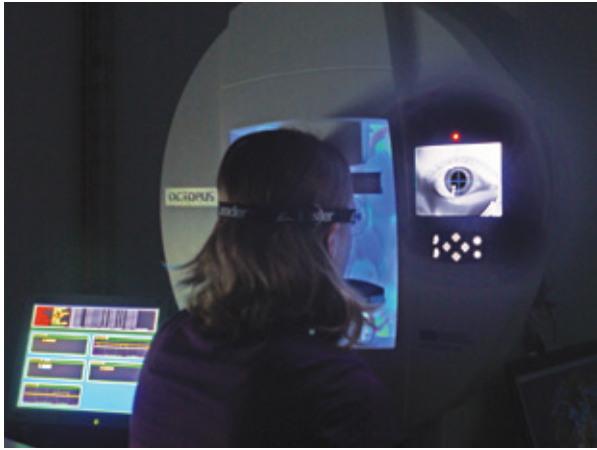

The new test to assess visual exploration behavior in the Octopus 900 perimeter.

Cognitive Performance and Driving Behavior in Older Adults

The objective of this study is to better understand how cognitive performance and aging influence individual driving behavior and traffic-related risks. We have developed a dynamic, computer-based test battery to measure driving-relevant cognitive and motivational competences such as processing speed, decision making, anticipation of speed, and motion perception. The test and the human-machine interface are specifically developed for elderly people and the system is intended to serve as a

screening tool to assess driving-relevant cognitive performance. In a study of 100 participants, we could show good correlation between the new computer-based tests, accident history and simulated driving performance. For that purpose, a commercially available driving simulator has been modified to study simulated driving behavior of elderly drivers while measuring neurophysiological parameters (e.g. eye movements, skin conductance). Based on these findings, we intend to derive cognitive training schemes that help older people to maintain driving relevant cognitive skills as long as possible. This project is funded in part by the "Fonds für Verkehrssicherheit".

Safmove – Safe Mobility of the Elderly in the Vicinity of their Home and on Journeys

This EU-project has two aims. The first one is to develop new means to improve and maintain cognitive performance and to prevent cognitive decline as long as possible. Hence, in collaboration with other European and Swiss researchers, we develop home-based cognitive and physical trainings based on innovative gaming platforms (e.g. Wii and Kinect) and specifically developed serious games. We will place a special focus on adaptive difficulty levels, allowing error-free learning that is expected to increase motivation, fun, and self-confidence. The second aim is to develop a navigational device that provides context- and location-based information and aids during outdoor activities. We expect that these two measures will help to breach the negative cascade of avoidance, i.e. by the fear of failure during cognitive challenges, which is commonly observed in patients with cognitive impairment.



Simulated driving during a visual exploration experiment. The test subject wears a helmet with an integrated eye tracking camera to measure gaze direction.

Selected Publications

Nef T, Riener R, Müri R, Mosimann UP (2013); Comfort of two shoulder actuation mechanisms for arm therapy exoskeletons - a comparative study in healthy subjects. *Med Biol Eng Comput*, [Epub ahead of print]

Gruber N, Mosimann UP, Müri R, Nef T (2012); Vision and Night Driving Abilities of Elderly Drivers. *Traffic Injury Prevention*, in press

Mosimann UP, Bächli-Biétry J, Boll J, Bopp-Kistler I, Donati F, Kressig RW, Martensson B, Monsch AU, Müri R, Nef T, Rothberger A, Seeger R, von Gunten A, Wirz U (2012); Consensus recommendations for the assessment of fitness to drive in cognitively impaired patients. *Praxis*, 101(7):451-64

Image Guided Therapy

Stefan Weber, Head of Research Group

Email: stefan.weber@artorg.unibe.ch

Phone: +41 31 632 75 74

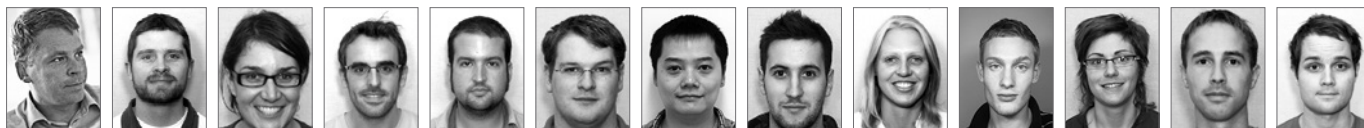

Stefan
Weber

Brett
Bell

Daphne
Wallach

Juan
Anso

Javier
Aparicio

Boris
Brun

Dawei
Chen

Matteo
Fusaglia

Kate
Gavaghan

Philipp
Müller

Delphine
Ribes

Grzegorz
Toporek

Tom
Williamson

Clinical Partners

Daniel Aebersold, Director and Head of Department Radiation Oncology

Daniel Candinas, Director and Head of Department Visceral Surgery and Medicine

Marco-Domenico Caversaccio, Co-Director and Clinical Partner, Director of ENT, Head and Neck Surgery

Jan Gralla, Consultant Neuroradiologist, Institute of Diagnostic and Interventional Neuroradiology

Johannes Heverhagen, Director and Head of Department of Diagnostic, Interventional and Pediatric Radiology

Joachim Kettenbach, Chief Physician, Interventional Radiology (EBIR)

Thomas Krause, Director and Head of Department Nuclear Medicine

Peter Manser, Head of Division of Medical Radiation Physics

Andreas Raabe, Director and Chairman Department of Neurosurgery

Gerhard Schroth, Director Institute of Diagnostic and Interventional Neuroradiology

George Thalmann, Director and Chairman Department of Urology

Research Profile

The Chair for Image Guided Therapy focuses on clinically related research and development activities in the broad area of stereotactic surgery. Clinical focus and suitability of projects is achieved through strong partnerships with clinicians at the Bern University Hospital who give insight into the predominant needs and deficiencies in today's surgical practices. Research activities aim at providing novel technologies for diagnostics and therapy to the interested clinical communities and enabling evaluation in clinical routine. Image processing, stereotactic instrument guidance, surgical robotics and rapid prototyping are used to augment the surgeon's abilities and ultimately improve surgical outcomes. Currently, new and traditional surgical technologies are exploited to explore novel applications in two focus areas: micro surgery on the lateral skull base, and soft tissue surgery on the liver.

Minimally Invasive Cochlear Implantation

Direct cochlear access (DCA) is a technique enabling minimally invasive insertion of a cochlear electrode through a small diameter tunnel. Anatomical structures within the mastoid create a natural corridor through which a tunnel may be drilled, however high accuracy is required due to the small diameter of this corridor. Together with the ENT department at Bern University Hospital, we have continued development of an image guided surgical robot system which can accurately drill a DCA according to a preoperative plan. Recently, the system has achieved an unprecedented accuracy of 0.15 ± 0.08 mm as shown in a cadaver study. The safety of the robotic procedure is also a major consideration: we have developed and patented an algorithm which correlates drilling forces with bone density information to determine the pose of a tool within the mastoid bone, independent of standard navigation errors. Also under investigation is a neuromonitoring device integrated into the robot system. With this we hope to

provide an early warning signal should the drill come too close to the facial nerve. The sensitivity and specificity of the system is currently being investigated in a live sheep study.



The image guided surgical robot system is able to achieve unprecedented accuracies during the drilling of a tunnel for minimally invasive access to the inner ear.

Stereotactic Interventional Procedures on the Liver

Percutaneous interventions such as radiofrequency or microwave ablation are gaining importance as a minimally invasive treatment of liver metastases with curative intent. Using these techniques small tumors can be destroyed with minimal damage to healthy liver tissue and without the risks associated with open-liver surgery. The success of these procedures is highly dependent on the accurate positioning of the ablation needles, typically achieved through repetitive CT acquisitions thus leading to excessive radiation exposure. In collaboration with the department of Diagnostic, Interventional and Pediatric Radiology a stereotactic instrument guidance system was developed

that enables the accurate placement of ablation needles. Throughout 2012 the guidance system has been used in 8 clinical interventions in Bern and Lausanne with positive outcomes.

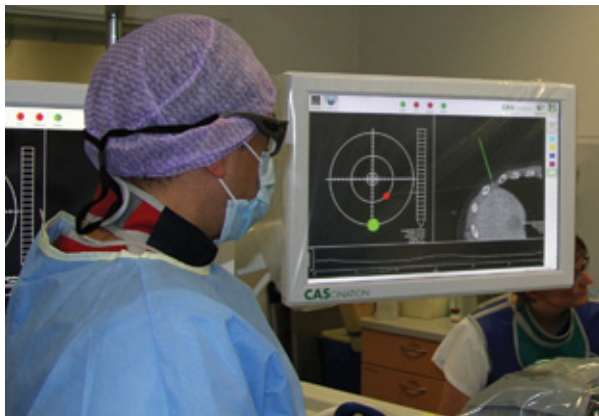

Stereotactic instrument guidance system assists in percutaneous, minimally-invasive therapies by co-displaying ablation needles in the context of patient anatomy.

Ultrasound-based Registration in Liver Surgery

Stereotactic navigation in open liver surgery enables surgeons to treat difficult and high risk cases. The main challenge is achieving an accurate registration between preoperative image data and the patient in the OR, a challenge compounded by the deformation and mobility of



Use of intra-operative ultrasound allows increased registration accuracy during open liver surgery.

the liver. To combat this, a fast and accurate registration in a small region of interest using navigated ultrasound was developed. The solution consists of multiple steps wherein a navigated ultrasound probe is used to identify key anatomical features to initialize the registration process, followed by a more accurate registration using a 3D ultrasound volume and the corresponding preoperative CT data. Finally, the accuracy of the registration can be verified with subsequent ultrasound images or a navigated instrument. The feasibility of the system was tested in a postoperative evaluation of 25 surgeries, with a mean navigation error of 6.1 mm.

Laparoscopic Liver Surgery

Laparoscopic liver surgery is an emerging technique allowing resection of tumors using minimally invasive keyhole access. Surgery is performed based on images from a miniaturized camera introduced into the abdominal cavity, displayed on an external screen. Our research includes the adaptation of stereotactic open liver surgery functionalities to this minimally invasive technique. A primary objective is the visualization of additional 3D CT/MRI derived liver anatomy directly on the laparoscopic video using augmented reality techniques. Together with Prof. Brice Gayet from Institut Mutualiste Montsouris in Paris and colleagues from Harvard Medical School we conducted first clinical testing of our technology; all relevant anatomical information was fused in the surgeon's field of view enabling better decision making and spatial orientation.



A CT/MRI derived liver anatomy is projected onto the laparoscopic view during tumor resection.

Selected Publications

Schmauss D, Schmitz C, Bigdeli, AK Weber S, Gerber N, Beiras-Fernandez A, Schwarz F, Becker C, Kupatt C, Sodjan R (2012) Three-dimensional printing of models for preoperative planning and simulation of transcatheter valve replacement. *Ann Thorac Surg.* 93(2): 31-33

Bell B, Stieger C, Gerber N, Arnold A, Nauer C, Hamacher V, Kompis M, Nolte L, Caversaccio M, Weber S (2012) A self-developed and constructed robot for minimally invasive cochlear implantation. *Acta Otolaryngol* 132(4): 355-360

Peterhans M, Oliveira T, Banz V, Candinas D, Weber S (2012) Computer-Assisted Liver Surgery - Clinical Applications, and Technological Trends, *Critical Reviews in Biomedical Engineering.* 40(3):199-220

Gavaghan K, Oliveira-Santos T, Peterhans M, Reyes M, Kim H, Anderegg S, Weber S (2012) Evaluation of a portable image overlay projector for the visualisation of surgical navigation data: phantom studies. *Int J Comput Assist Radiol Surg.* 7(4): 547-556

Patents

Bell BJ, Williamson T, Weber S. System and Method for estimating the spatial position of a tool within an object. European Patent EP12168772.7

Lung Regeneration Technologies

Olivier Thierry Guenat , Head of Research Group

Email: olivier.guenat@artorg.unibe.ch

Phone: +41 31 632 76 08

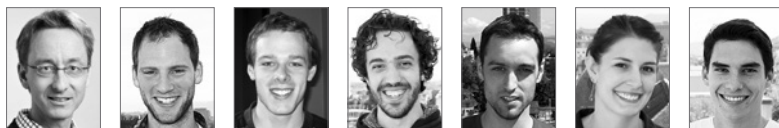

Olivier Guenat

Marcel Felder

Jakob Larsen

Emanuele Marconi

Yves Mermoud

Janine Ruppen

Andreas Stucki

Clinical Partners

Thomas Geiser, Director Division of Pulmonary Medicine

Ralph Schmid, Director Division of General Thoracic Surgery

Matthias Gugger, Head Non-Invasive Ventilatory Care, Division of Pulmonary Medicine

Research Profile

The Lung Regeneration Technologies (LRT) Group, which was established in November 2010, is a collaborative effort between the ARTORG Center, the Division of Pulmonary Medicine and the Division of General Thoracic Surgery both from the University Hospital (Inselspital) of Bern and the Swiss Center for Electronics and Microtechnology (CSEM SA).

The objectives of the LRT Laboratory are to develop advanced microfluidic devices able to recreate in-vivo-like conditions of the lung, including the complexity of the alveolar-capillary barrier, the gas exchanges and the mechanical stimulation of the respiratory movements of the lung. Microfluidic devices offer structures with length scales that are comparable to the intrinsic dimensions of mammalian cells. Such microsystems have the capability to accurately control the cell microenvironment and are promising alternatives to animal studies. The devices will particularly be devoted to investigate the pathophysiology of different lung diseases. For the future, such bioartificial lung-on chip systems are deemed to be extremely important for the understanding of fundamental cellular or molecular mechanisms that take place in the lung and are also intended to be implemented for personalised medicine approaches in which the number of cells is limited.

Reproducing Alveolar Epithelial Microinjuries

Pulmonary Fibrosis (PF) is a chronic, progressive and fatal lung disease with rising prevalence among western countries. Despite this growing clinical demand, therapeutic options are currently still highly restricted and lung transplantation remains the only glimmer of hope for most of these patients. Therefore, new models accurately reproducing key elements of this devastating disease are urgently needed to better understand its underlying pathophysiology and to develop efficient therapeutic strategies. Recent evidence led to the hypothesis suggesting improper alveolar reepithelization in response to microinjuries is a trigger for fibrotic processes. The sequential microinjuries lead to disruption of alveolar epithelial integrity. Traditionally, such epithelial microinjuries are investigated in-vitro using a scratch test technique using a sterile glass or a plastic pipette tip. In sharp contrast to the latter technique, which detaches and damages the cells,

leading to release of intracellular content and cellular debris into the nutrition medium, we have developed novel microfluidic models of alveolar epithelial microinjuries that better reflect the in-vivo situation. For this, we designed microfluidic platforms made of poly-dimethylsiloxane (PDMS), fabricated by rapid prototyping techniques. The microfluidic system consists of tiny microchannels whose cross-sections are comparable to the diameter of a human hair. Type II alveolar epithelial-like (A549) cells were cultured under permanent perfusion of culture medium. Upon confluence, cells were selectively exposed to a focused flow of acidified cell culture medium. This solution, whose pH is similar to gastric acid microaspirations – epidemiologically highly correlated with idiopathic pulmonary fibrosis – selectively injured the epithelial layer in the middle part of the microchannel. Microinjuries with wound sizes of 300µm down to 50µm – similar to those found in-vivo – could be reproduced on chip.

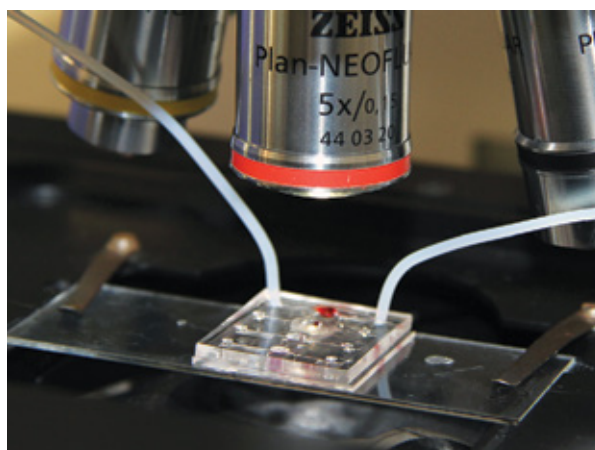

Microscopic observation of a perfused cell culture on a microfluidic chip. The chip is made of a microstructured soft polymer (PDMS), which is bonded on a glass slide.

Porous Polymeric Membrane for Cell Culture

Current in-vitro techniques used to investigate the pathophysiology of pulmonary diseases are mostly performed on rigid cell culture plates or porous membranes. Such in-vitro models poorly reproduce the in-vivo conditions of the lung, in particular the mechanical stress induced by the respiratory movements and the shear stress generated

by the blood stream. In sharp contrast, our objective is to develop a breathing lung-on-chip equipped with a thin stretchable, porous membrane, able to mimic the mechanical stress of the alveolar membrane. Alveolar epithelial cells could successfully be cultured on such porous membrane.

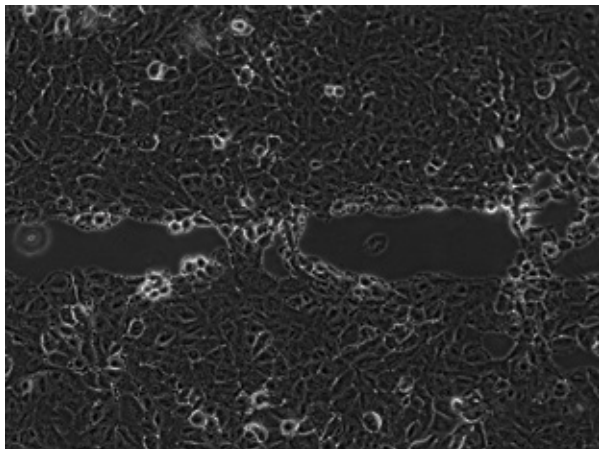

Phase contrast image of A549 cells cultured in a 750um wide microchannel, with epithelial microinjuries following a focused flow of acidified cell culture medium pH 2.5.

Chemoresistive Microfluidic Platform for testing Lung Cancer Spheroids

Lung cancer remains the leading cause of cancer deaths worldwide. The chemotherapeutic treatment options

for such pathologies are currently mainly based on the stage of the cancer and on the patient's overall health and lung function. To increase the chemotherapeutic treatment efficiency, one envisages to test the patients' own cells in order to better predict the individual response to a specific therapy. This new paradigm is called "personalized medicine". To tackle this challenge, novel instruments, that allow small "in-vivo-like tumors" to be cultured and analyzed, are needed, in order to better predict the chemotherapeutic response for each patient. A microfluidic platform on which single spheroids of cancer cells can be loaded, trapped and tested on chemotherapeutic drug response is currently under development in our laboratory. First assays were performed with a malignant pleural mesothelioma (MPM) cell line (H2052). MPM is an asbestos-related malignancy that is highly resistant to current therapeutic modalities. MPM spheroids, a 3D cell culture that better reflect the in-vivo behavior of cells in tumor tissues, were formed and loaded on the microfluidic chip made of PDMS rapid prototyping. The spheroids were continuously perfused for 48 hours with different concentrations of Cisplatin, one of the standard chemotherapeutic drugs used to treat mesothelioma patients. The supernatant of the cell cultures were then analyzed for cell viability and compared to results obtained in monolayer cultures and non-perfused spheroid cultures. Our results show that the 50% inhibitory concentration is seven times higher in spheroids than in monolayer cultures, whereas it was twice as high for perfused spheroids as for non-perfused ones.

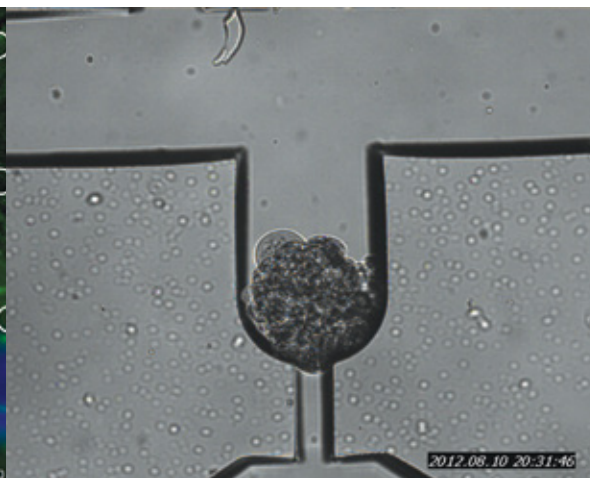
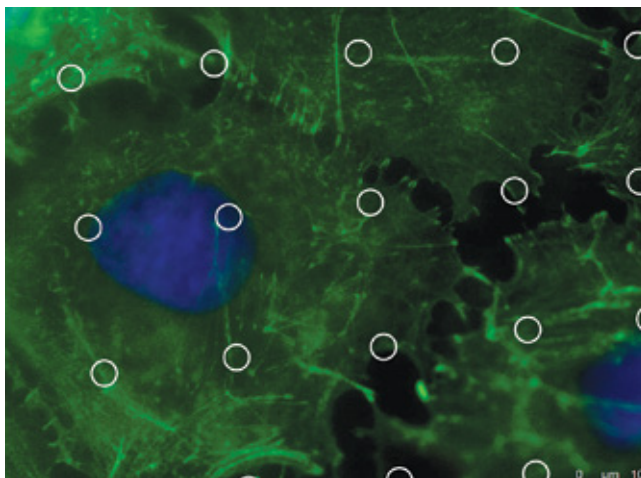

Left: Fluorescent image of alveolar epithelial cells (A549) cultured on a thin, porous membrane. The array of 5um pores are drawn in white. DAPI (blue), Actin (green).
Right: Picture of a 160um in diameter lung cancer spheroid trapped in a microfluidic cavity.

Selected Publications

Felder M, Sallin P, Barbe L, Haenni B, Gazdhar A, Geiser T, Guenat O (2012) Microfluidic Wound-healing Assay to Assess the Regenerative Effect of HGF on Wounded Alveolar Epithelium. *Lab on a chip* 12:640–646

Ruppen J, Cortes-Derick L, Marconi E, Felder M, Barbe L, Schmid RA, Karoubi G, Guenat O (2012) Microfluidic platform for chemoresistive testing of lung cancer stem cells. *British Journal of Surgery* 99(S5):1–24

Patents

O. Guenat, S. Generelli
Disposable cartridge for ion selective electrodes for long term monitoring
USP 61/609615, 2012.

Ophthalmic Technology

Jens H. Kowal, Head of Research Group

Email: jens.kowal@artorg.unibe.ch

Phone: +41 31 632 75 04

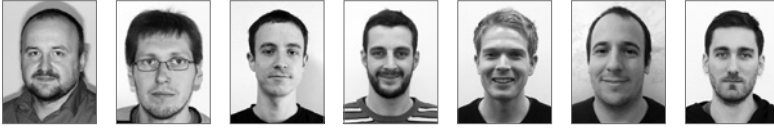

Jens H. Kowal

Robert Anniés

Pascal Dufour

Tobias Rudolph

Michael Rügsegger

Patrick Steiner

Sandro deZanet

Clinical Partners

Sebastian Wolf, Director of the Department of Ophthalmology

Research Profile

The Ophthalmic Technology Group is dedicated to the development of innovative diagnostic and therapeutic instruments and techniques in the area of ophthalmology. The novel engineering solutions should allow for an increased treatment precision, while at the same time diminish the risks for patients and reduce the costs of the intervention. We are focused on projects that are clinically relevant and we are committed to advancing project developments to a state from which potential clinical benefit can be assessed. The successful combination of applied research and development on one side and clinical implementation on the other represents the main challenge of our group. The Ophthalmic Technology Group consists of a multi-disciplinary team of engineers and clinicians. Our core competencies are in mechatronic systems design, signal processing, computer-vision and computer-graphics. The ophthalmic technology group has strong ties to the Ophthalmology Department of the Inselspital but also research collaborations to other institutions nationally and internationally.

External Beam Radiotherapy (EBRT) of Intraocular Tumor

A challenging topic in ophthalmology is the treatment of intra-ocular tumors with radiation therapy. Exact tumor shape delineation during the planning process and accurate execution of the treatment plan are vital for successful treatment outcome. EBRT by nature is a non-invasive treatment. However, currently there are no appropriate tracking systems available that facilitate non-invasive tracking of the tumor during the treatment. This project will help to bring back the noninvasiveness of EBRT to tumor treatment in the eye. We are developing a planning system that allows the fusion of different image modalities (CT, MRI, Fundus-Photography) into one patient specific eye model enabling us to assess tumor shape as imaged in the different modalities but in the same planning context. To guarantee optimal plan execution we are developing a contact free, OCT based, tracking system to track the motion of the eye during the treatment. Tracking the anterior segments of the eye and knowing, thanks to the patient specific eye model, the spatial relation between anterior eye structures and the posterior tumor will provide a very accurate tumor tracking.

Computer Assisted Selective Retina Therapy (SRT)

Laser photocoagulation of the retina has become an

established treatment modality for many diseases, some of which have an enormous social and economic impact. The greatest limitation of conventional laser therapy is the irreversible collateral damage it causes to adjacent retinal structures such as the photo receptor layer. With the development of the new SRT, a treatment is available that selectively destroys the retinal pigment epithelium (RPE). The RPE layer regenerates after a few days, a normal metabolism of the retina will be re-established and consequently the cause of many retinal diseases vanishes. Although highly beneficial to the patient, SRT is challenging to apply, because lesions (at an optimal SRT level) are invisible. Additionally, typical laser setups using a manually steered laser slit lamp are technically very demanding for the ophthalmologist. To overcome these problems, we are working on a computer assisted laser navigation system that can place laser lesions automatically. It will improve accuracy, execution time and patient safety considerably. The deposition of the correct amount of laser energy for each lesion is crucial for an optimal treatment result. Therefore, we are developing a new dosimetry control for SRT using OCT. With OCT imaging, a map of the optical properties of the retinal layers is recorded and a 3D tomogram of the area under investigation is provided. Changes in reflectivity or the distortion of sample layers can thus be detected, making OCT a promising modality for SRT dosimetry control. OCT is completely non-invasive and operating in the near-infrared range. With OCT it is expected that during SRT, the progress of bubble formation and cell destruction can be monitored in real-time.

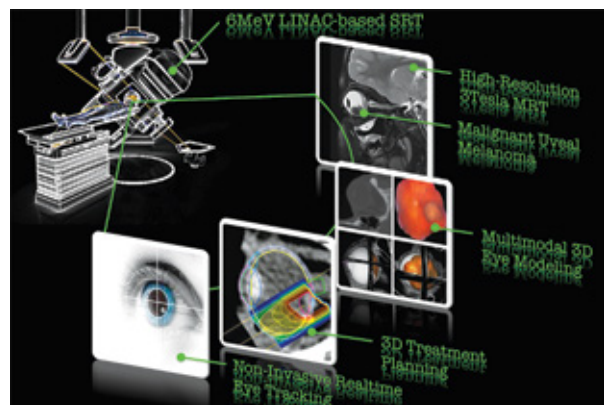

Setup of the computer assisted photon beam therapy project, showing the LINAC therapy device and the individual parts of the planning and the treatment execution procedure.

A high-resolution OCT system was designed, realized and tested and preliminary results of ex-vivo experiments proved the ability of OCT to detect the laser lesions after the treatment. In future steps, the therapy and monitoring

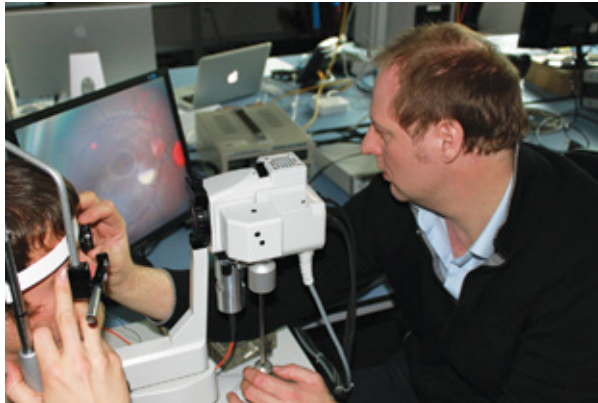

Treatment setup for SRT Laser system. Treatment delivery device is shown in the middle. The operator is on the right and the patient on the left side.

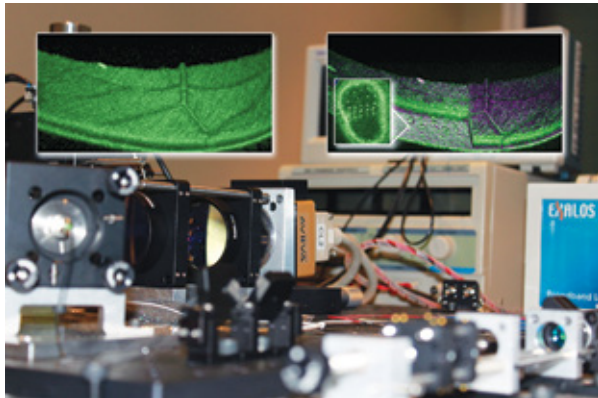

Spectrometer hardware for dosimetry control together with two images showing a 3D rendering of an OCT slice stack. On the left, the original slice stack and on the right, the same slice with a segmented RPE layer and the lesions placed.

system will be combined to enable a real-time monitoring of the treatment including an automated detection and thresholding of the therapy laser spots as well as the option for a long-term therapy progress analysis using the same OCT system.

Automatic Quantitative Evaluation of OCT Datasets

Optical Coherence Tomography (OCT) is an interferometry based, non-invasive image modality. It is used in ophthalmology to image the retinal cell layers for diagnostic purposes, research into disease progression as well as clinical trials. To facilitate quantitative evaluation of OCT datasets, automatic methods have to be employed.

We are developing algorithms capable of automatically segmenting volumetric OCT datasets with accuracy in the order of the inter-observer variability. The methods can segment healthy eyes as well as pathologic degenerations in patient eyes with Age-related Macular Degeneration (AMD). This enables us to deploy the algorithms e.g. in AMD studies. To facilitate automatic OCT data processing in large scale studies it is indispensable to automatically assess the image quality of individual OCT data. We are working on algorithms that would allow unsupervised quality control of OCT data.

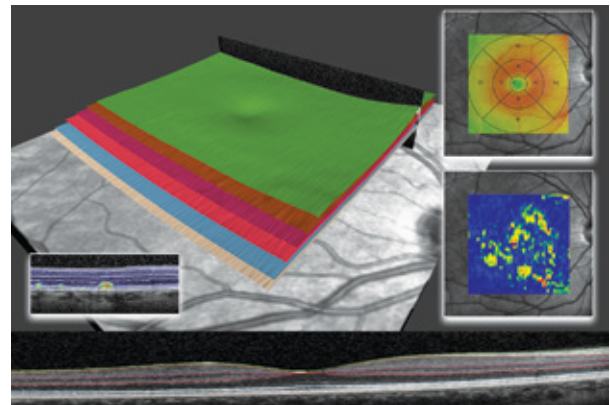

OCT Segmentations of the retina from both healthy as well as pathologic eyes.

Selected Publications

Rueegsegger M, Bach-Cuadra M, Pica A, Amstutz C, Rudolph T, Aebersold D, Kowal JH (2012) Statistical Modeling of the Eye for Multimodal Treatment Planning for External Beam Radiation Therapy of Intra-Ocular Tumors. *Int. Journal of Radiation Oncology Biol. Phys* 84(4):e541-e547

Dufour PA, Ceklic L, Abdillahi H, Schröder S, Wolf-Schnurrbusch U, Kowal JH (2013) Graph-Based Multi-Surface Segmentation of OCT Data Using Learned Hard and Soft Constraints. *IEEE Trans on Med Imaging* J2(3): 531-543

Dufour PA, Abdillahi H, Ceklic L, Wolf-Schnurrbusch U, Kowal JH (2012) Pathology Hinting as the Combination of Automatic Segmentation with a Statistical Shape Model. *MICCAI 2012*, 599-606

Dufour PA, DeZanet S, Wolf-Schnurrbusch U, Kowal JH (2012) Classification of Drusen Positions in Optical Coherence Tomography Data from Patients with Age-Related Macular Degeneration. *21st International Conference on Pattern Recognition (ICPR)*, November 2012, Tsukuba, Japan pp. 2067-2070

Rueegsegger M, Cuadra M, Pica A, Amstutz C, Rudolph T, Aebersold D, Kowal, JH (2012) Statistical modeling of the eye for multimodal treatment planning for external beam radiotherapy of intraocular tumors. *Strahlentherapie und Onkologie*, 188(8): 23-760

Patents

Kowal JH, Amstutz CA, Rudolph T, Automatic Image Optimization System for Stereo-Microscopes (Patent Application EP 111 93 583.9), European Patent Office, 2012.

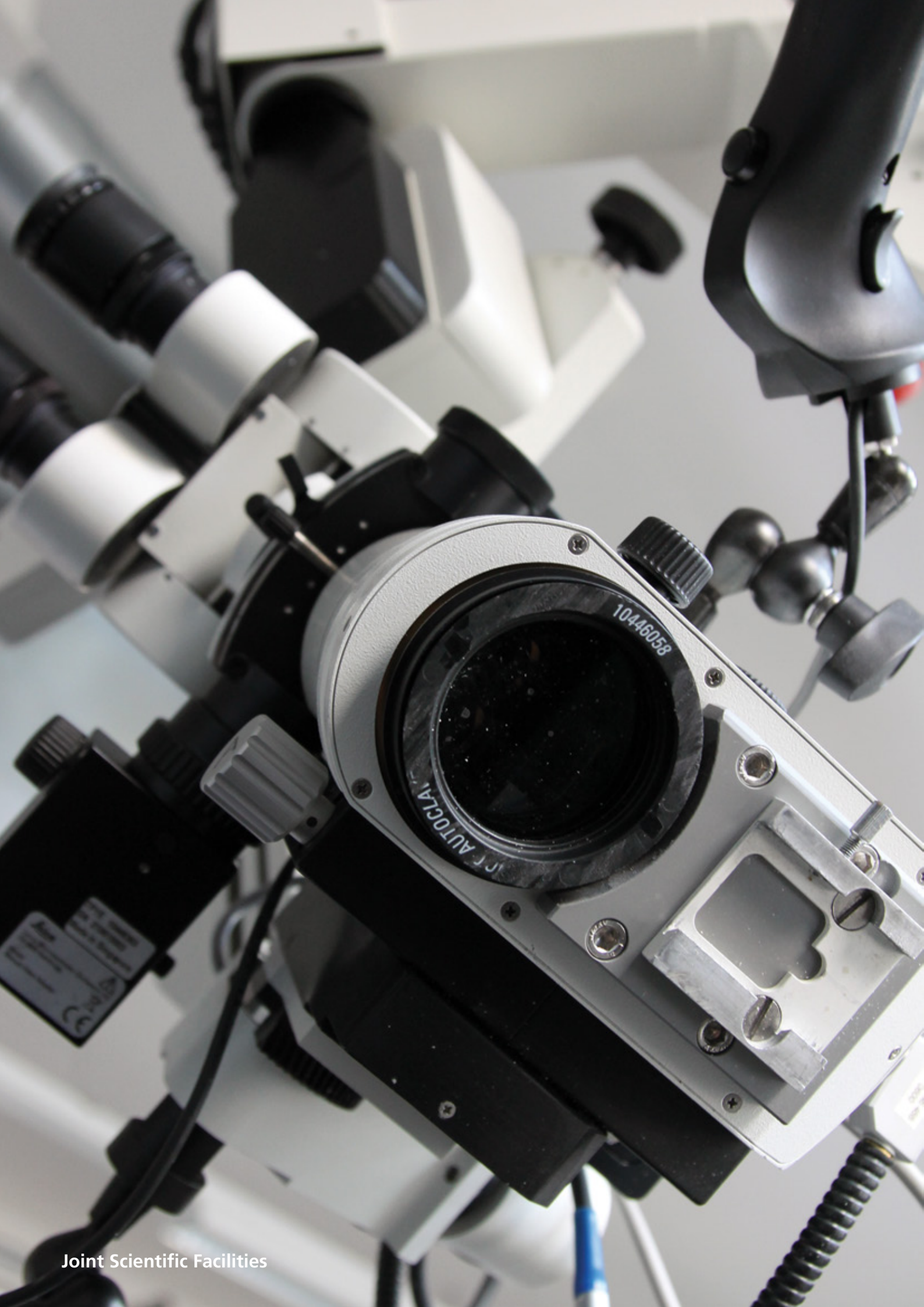

Mechanical Design and Production

Urs Rohrer, Head of Mechanical Design & Production

Email: urs.rohrer@istb.unibe.ch

Phone: +41 31 631 59 35



Urs
Rohrer

Ronald
Ramseier

Sara
Corinti

Patrick
Moser

Lukas
Rufener

Sascha
Weidner

The primary function of the Mechanical Design and Production (MDP) group is the co-development and manufacturing of mechanical and electro-mechanical components related to the research pursuits of the ISTB and ARTORG. The MDP group supports all levels of the design and manufacturing process from concept to production. This includes computer assisted design (CAD) modelling, prototyping and production with technical drawings, standard tooling, computer assisted manufacturing (CAM), a CNC-milling-machine and a CNC-lathe. We also support industrial and academic external research collaborators with their mechanical design and production needs.

The MDP group has a secondary role in training. This training encompasses the skills required to safely and proficiently operate machine shop tooling and equipment, the knowledge required to achieve the best results with a variety of materials and the skills needed to efficiently manage the design and production workflow.

Training and Education

On the 1st of August 2012 Lukas Rufener became our new apprentice Polymechnic. He is currently completing his basic training for 6 months at the Astronomic Institute at the University of Bern before continuing with us as part of the MDP group.

Our apprentice Patrick Moser completed his basic training exam at the end of the second year and we congratulate him for his excellent results. In the coming two years his training will focus more on CAD-CAM technologies and manufacturing more ambitious parts.

In June Sara Corinti completed her apprenticeship exam successfully with a good result and we congratulate her. After completion of her training she was employed until the end of December in our machine shop as a Polytechnician.

Research Equipment Design & Manufacturing (ISTB)

As expected, the requirements of a machine shop supporting research in the biomedical engineering field are as diverse as the research field itself. The variety of subjects researched in the ISTB yield a number of diverse design and production requests from prototype clinical and surgical tooling to fixtures for mechanical, biological and kinematic testing, as well as imaging system accessories and calibration equipment. The following illustrations highlight a few of this year's projects

Compression Device

In 2005 a vertebral compression chamber was constructed by the MDP group, designed for the application of loading forces up to 4 kN. This year two further chambers of the same type, redesigned and modified to allow loading forces of up to 10 kN, were and successfully implemented as part of Sara's final examination.

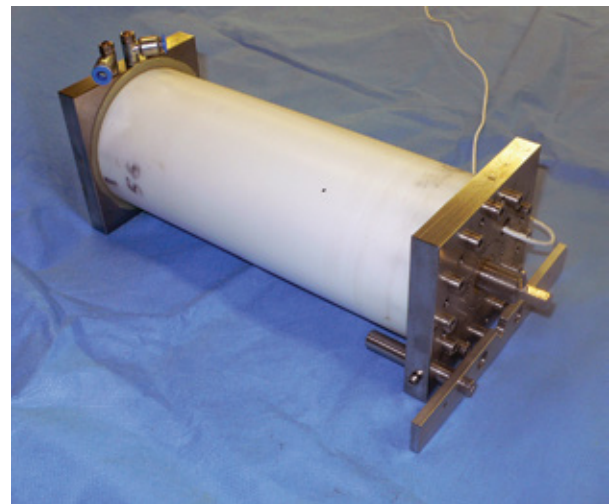

Modified vertebral compression device, allowing loading forces of up to 10 kN.

PMMA Plate Calibration Phantom

A plate phantom, constructed from Acrylglass (PMMA), was constructed to serve as a universal calibration body

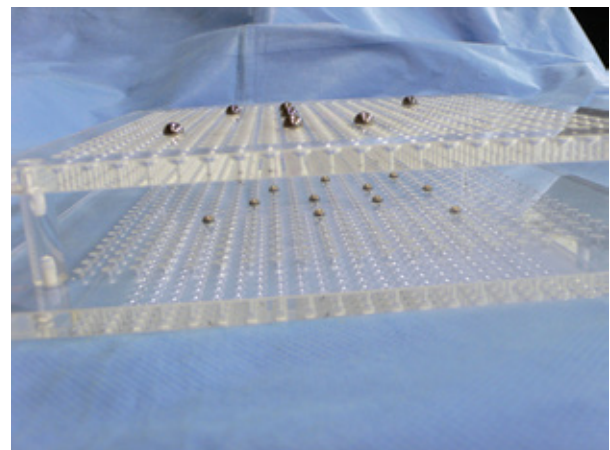

PMMA plate calibration phantom for calibration of C-Arm imaging.

for C-Arm imaging and navigation in orthopaedic surgery. The phantom enables different patterns of spheres on two separate planes to be defined, allowing the optimal location of a contrast element to be determined for a future, final, universal calibration phantom.

Spine Hexapod

A robotic device was designed and developed in order to measure the force-displacement characteristics of two adjacent vertebral bodies. The accuracy requirements proved to be a significant challenge for the design and manufacture of the device.

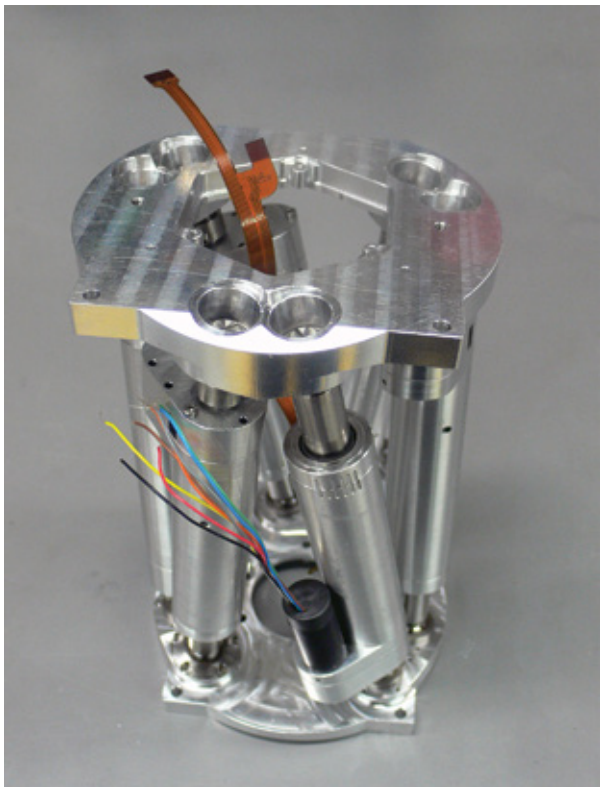

Robotic hexapod designed for the measurement of force-displacement characteristics of vertebral bodies.

Macro Tensile Test Setup

Over the last few years we have created a number of test pieces for the Dentistry Clinic at the Bern University



Components of the macro tensile test set up for testing of dental filling samples.

Hospital, as part of an ongoing collaboration. In 2012 we successfully developed a number of molds for new dental filling designs as well as performing the subsequent tensile testing using a setup which included a collet and a special sample fixture.

Research Equipment Design & Manufacturing (ARTORG)

The workshop at the ARTORG Center was led by Sascha Weidner from January 2011 until the end of February 2012; we thank him for his work and wish him all the best for the future. The workshop leadership was taken over by Ronald Ramseier, former polymechnic at the ISTB MDP, after the restructuring of the ARTORG Center, on the 1st of October 2012 and a number of projects have already been completed since he began.

As the ARTORG workshop pursues many of the same aims as the MDP group at the ISTB, and as much of the production equipment is located at the MDP, a partnership was formed between the two groups. This partnership will continue and grow during 2013.

High Accuracy Drill Spindle

The surgical robot OtoBot was developed specifically for minimally invasive cochlear implantation, a procedure which requires an exact and repeatable navigation and drilling process. Conventional surgical drill bits, constructed of stainless steel, are much more compliant than high speed steel or carbide tools used in the machining industry. These compliant tools, combined with a certain degree of backlash in the surgical drill spindle, result in poor drilling accuracy. In order to reduce errors arising from the drilling process, a new backlash free high speed drill spindle was developed.



Custom drill hand piece for a minimally invasive robotic system.



Opto-Acoustic Laboratory

Contact:

wilhelm.wimmer@artorg.unibe.ch

jens.kowal@artorg.unibe.ch

A special laboratory for the conduction of optical and acoustic experiments is available at the ARTORG center. The anechoic room is vibrationally decoupled from the rest of the building and complies with the ISO 8253 series for audiometry.

In addition to standard optical testing material the laboratory is equipped with a medium sized vibration isolation table (2x1m) for the conduction of optical experiments in a controlled environment. Currently, most of our optical work in this lab relates to optical coherence tomography imaging. For experiments in this application domain the lab is further equipped with specific devices such as broadband light sources and spectrometers.

Our custom-made directional hearing facility for complex speech in noise and sound localization experiments is currently in use for several clinical studies. If necessary, standard audiometry instruments (e.g. audiometer, tympanometer, otoacoustic emission or brainstem evoked response audiometry) are available in the laboratory.

Demonstration and Test OR

Contact:

stefan.weber@artorg.unibe.ch

brett.bell@artorg.unibe.ch

The ARTORG Center places a strong focus on the creation and development of relationships with clinical partners, allowing not only the development of new projects but additionally the transfer of existing projects into a clinical setting. The ARTORG Virtual OR is a facility designed to enable an accurate simulation of a surgical environment, thereby allowing researchers to anticipate and minimize problems related to positioning of equipment, mounting and assembly procedures, cable routing, and information display. Workflows can be optimized and validated in cooperation with clinical specialists before equipment is integrated into a real OR setting and the facility also gives clinical partners the ability to observe and practice new clinical techniques with developed tools on a diverse range of anatomical phantoms.

The Virtual OR contains a variety of equipment commonly found within a standard OR setting: a Schaerer® OR table, Trumpf® medical lighting and gantry as well as wall mounted flat screen monitors, including an Alioscopy 3D monitor. Navigation technologies including optical and

electromagnetic tracking systems with associated passive or active tools are available as a test bed for evaluating software and hardware functionality or clinical feasibility. A custom built 5-axis serial robot with a 200 mm radius hemispherical workspace is available for micro-surgical applications, while a second 4 DoF robot system dedicated for interventional procedures is available for investigation of percutaneous tumor ablations. Ancillary equipment such as a surgical microscope, ultrasound, neuromonitoring, and drilling systems are also available, as well as a coordinate measurement arm (FARO measurement technologies) for high accuracy metrology applications.



Driving Simulation Laboratory

Contact:

tobias.nef@artorg.unibe.ch

The Gerontechnology and Rehabilitation Group has established a driving simulation laboratory to study the neurophysiology of driving in healthy participants and in patients with cognitive impairment. The major component of the system is a fixed frame driving simulator (F12PI-2/A88, Foerst GmbH) with driver and co-driver seats. Three projectors (Ultra Short Focus LCD projector, Sonya) with 1024x768 pixel resolution project the virtual driving scene onto three canvases (1.80 x 1.39 m). The canvases are positioned in front of the driver, creating a 180° horizontal and 40° vertical field of view. Three computers running Microsoft Windows 7 (Microsoft Corp.) are used to control the simulation: one computer calculates and controls the dynamic scenario; the others are responsible for rendering the graphics at 35 Hz. To avoid interferences and distractions to the driver, the driving simulator is installed in a temperature-, light-, and noise-controlled room. We use custom-made virtual driving environments

in combination with appropriate projection technologies to increase user-comfort and reduce simulator sickness.

Sensors to measure the physiological responses of the driver are integrated into the setup: visual fixations are recorded with a head-free eye tracker with video-based corneal reflection tracking (SMI iView X HED). Heart rate, respiratory rate, skin temperature and skin conductance are measured by sensors from g.tech medical engineering GmbH. The primary use of the driving simulator is for research purposes. It is not suitable for clinical fitness-to-drive assessments.



Computer Simulation & Modeling

Contact:
justyna.czerwinska@artorg.unibe.ch
philippe.buechler@istb.unibe.ch

Finite element modeling facilities include implicit and explicit tools to simulate material and structural response under various loading conditions, multi-physics simulation software environments as well as custom made finite element code and material subroutines. Two multiprocessor Linux servers (16 cores 64bits Xeon processors with 50GB and 250GB memory) are available for simulation.

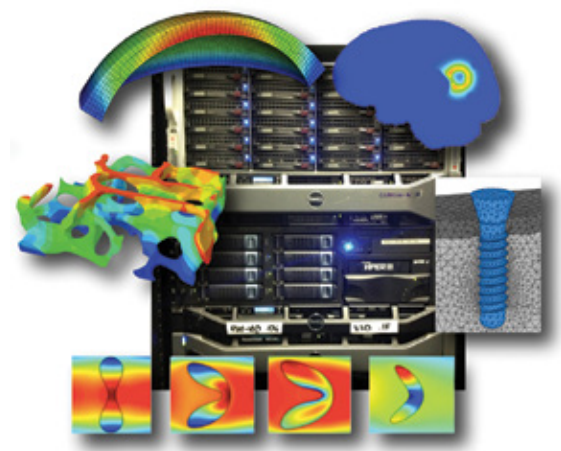

The following finite element analysis software tools are currently in use:

- ABAQUS/Standard

- ABAQUS/Explicit
- Comsol Multiphysics
- FEBio
- Molecular Dynamics simulations with LAMMPS

PDMS and Hot Embossing Rapid Prototyping Equipment

Contact:
olivier.guenat@artorg.unibe.ch

The ARTORG Center is fully equipped with poly-dimethylsiloxane (PDMS) rapid prototyping technologies as well as a hot embossing press for the micro-fabrication of hard polymeric material such as COC, PS or similar materials. The precision hydraulic press PW 10H from the company P/OWeber is equipped with heating plates and digital temperature regulators, allowing for accurate control of temperatures up to 300°C. This equipment is suitable for the fabrication of small to medium production runs. The lab press has the capability to hot emboss polymeric parts with high precision, with an applied force of up to 130kN to a surface of 165mm in diameter.



Microscopy for Imaging of Material and Biological Samples

Contact:
olivier.guenat@artorg.unibe.ch

The Zeiss AxioPlan is an upright microscope, equipped with a motorized stage, allowing for automatic imaging of material and/or biological samples in space and time.

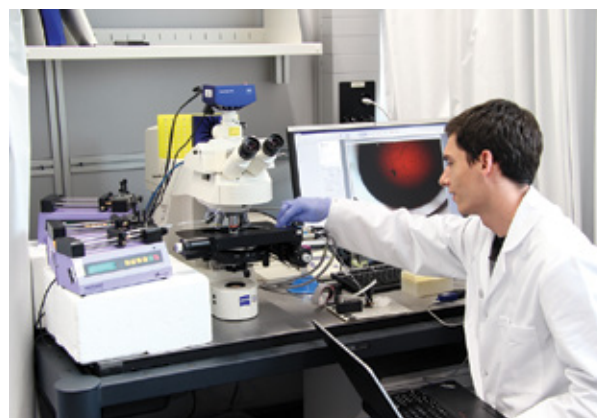

Reflection and transmission images can be performed in phase contrast and fluorescent modes and are recorded on a high resolution camera (Zeiss Axio Cam HRc). The microscope is also equipped with long distance Plan Neo-Fluar objectives (20x and 40x), as well as several fluorescent filters.

Biomechanics Laboratory

Contact:
philippe.zysset@istb.unibe.ch

Biomechanics testing facilities include a state-of-the-art preparation room for biological tissues and a materials testing laboratory specifically devoted to biological tissues. The laboratory allows multiscale mechanical testing from nanoscopic (extra cellular matrix) to macroscopic (whole organ level) length scales. Systems such as nano-indentation (CSM UNHT) or axial-torsional materials testing (MTS MiniBionix 858) equipped with optoelectronic motion capture are complemented by custom made experimental devices (Spine Tester and Microtensile Tester).



Rapid Prototyping Laboratory

Contact:
nicolas.gerber@artorg.unibe.ch

The ARTORG Center and ISTB share a Rapid Prototyping Lab (RP-Lab), in which objects with arbitrary forms, shapes and colors can be created using a ZCorp printer. Objects are produced through the layer by layer deposition of liquid glue and color on to thin (i.e. 0.1 mm) layers of powdered material (typically plaster); objects durability is then achieved through infiltration with a special resin. 3D printed objects can be used for a variety of purposes: prototypes can be produced from CAD data to validate design phases and objects can also be created from patient specific medical image data, representing anatomical, functional and structural information. Additionally,

experience, samples and an active network is available to provide additional means of rapid prototyping such as selective laser sintering (SLS) of metal parts.



Electronics Laboratory

Contact:
jens.kowal@artorg.unibe.ch

Both institutes are equipped with state of the art electronics laboratories to design, produce and test the complex electronic circuitry needed for the development of medical technology. More specifically, the design of digital and analog layouts with industry standard design software (Altium Designer), production and population of PCBs or prototype boards, as well as electrical and functional testing of components, can be carried out.

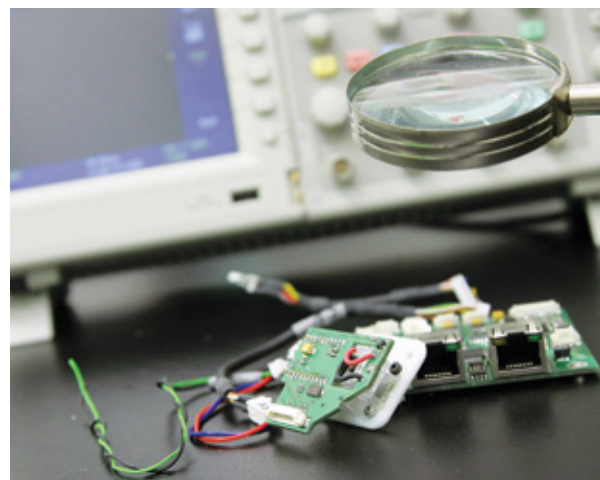

Dry and Wet Laboratories

Contact:
magnus.jonsson@artorg.unibe.ch

In addition to electrical and mechanical fabrication and testing facilities, dry and wet laboratories are available for in-vitro testing of cardiovascular devices and artificial organs. The experimental equipment includes:

- Computer controlled cardiovascular simulator for testing of heart valves and heart assist devices
- Data acquisition systems
- Peristaltic and centrifugal pumps
- Hydraulic pressure & flow sensors
- Dark room for flow visualization
- Viscometer for rheological tests

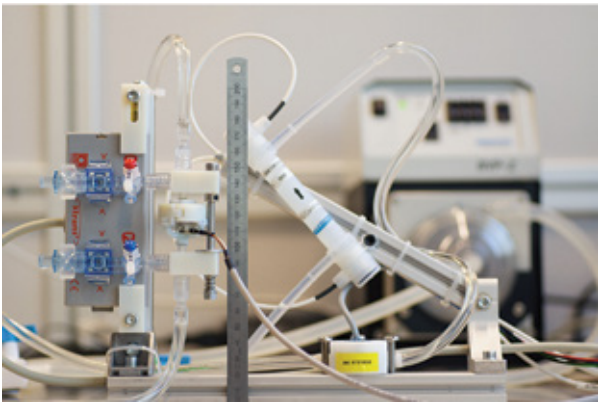

The VSD offers tools to manage and share research data, focusing specifically on medical image data and statistical shape models.

A multiprocessor Windows Server, with 10TB of currently available storage space, is hosting the VSD Website, including a collection of 300GB high quality CT datasets. Microsoft Internet Information Server, Microsoft SQL Server and DOTNET technology combined with open-source frameworks (Bootstrap, jQuery, Clear-Canvas) are used to ensure an efficient user experience. The entire VSD setup located at the ISTB is mirrored to the HTI Biel, ensuring constant service availability.

The Virtual Skeleton Database

Contact:
philippe.buechler@istb.unibe.ch
www.virtualskeleton.ch

The ISTB, in collaboration with the University of Applied Sciences in Biel, is hosting and actively developing an open access collaboration platform for scientific research.

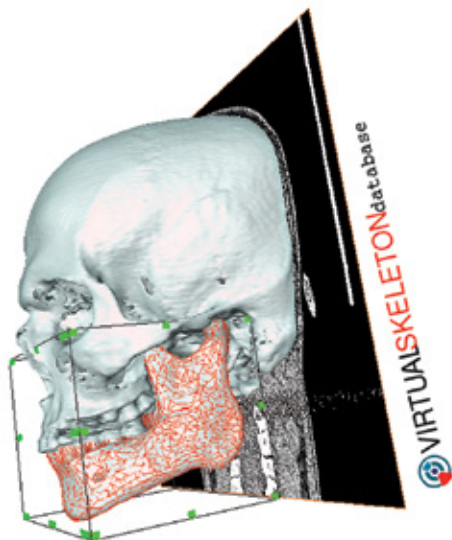

ACKNOWLEDGMENTS

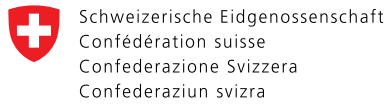

Innovation Promotion Agency CTI

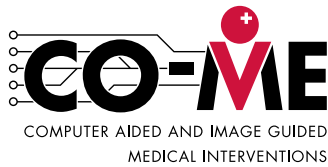

ACKNOWLEDGMENTS



Research institutions such as the ISTB and the ARTORG Center depend significantly on financial support from a number of funding agencies including governmental and non-governmental institutions, the Swiss and international medical technology industry and private sponsors. We are indebted to the University of Bern and the collaborating clinical partners for their generous contributions. We graciously and specifically would like to thank the Swiss National Science Foundation for their support and the federal CTI Innovation Promotion Agency for providing

R&D matching funds. In addition, support in the form of equipment, donations, or finances provided by various foundations and companies for a large number of specific research projects, is gratefully acknowledged. We would also like to thank the Inselspital Bern as well as our national research partners for great collaborations during the past year, most notably with the Swiss Center for Electronics and Microtechnology, CSEM, the Swiss Institutes of Technology and the Bern University of Applied Sciences BFH.

COMPLETED DISSERTATIONS

Serena Bonaretti

Statistical models of shape and density for population-based analysis of bone mechanics with applications to fracture risk assessment and implant design

Habib Bou-Sleiman

A Computational Anatomy Approach to Orthopaedic Research

Samantha Chan

Evolution of in vitro organ culture model for the intervertebral disc

Huanxiang Lu

Multi-modal Deformable Registration for Magnetic Resonance Image

Luca Scarnato

Food recognition based on computer vision and machine learning methods

Steffen Schumann

Ultrasound and X-ray based determination of pelvic orientation and shape – development and clinical evaluation

Christof Seiler

Trees on Geometrical Deformations to Model the Statistical Variability of Organs in Medical Images

Harald Studer

Simulation of Refractive Surgery for Optimization of Vision Correction

AWARDS

Alumni MedBern Award

Ruppen J, Cortes-Dericks L, Marconi E, Barbe L, Schmid R, Karoubi G, Guenat O
Microfluidic platform for chemoresistive testing of lung cancer cell spheroids.
Day of Clinical Research, Inselspital, Bern, Switzerland

Best Free Experimental Communication

Ruppen J, Cortes-Derick L, Marconi E, Felder M, Barbe L, Schmid RA, Karoubi G, Guenat O
Microfluidic platform for chemoresistive testing of lung cancer stem cells.
Swiss Society for Thoracic Surgery, Davos, Switzerland

Best Basic Science Article of the year

Stieger C, Caversaccio M, Arnold A, Zheng G, Salzmann J, Widmer D, Gerber N, Thurner M, Nauer C, Mussard Y, Kompis M, Nolte LP, Häusler R, Weber S
Development of an auditory implant manipulator for minimally invasive surgical insertion of implantable hearing devices.
The Journal of Laryngology and Otology, The Royal Society of Medicine, London, England.

Best Poster Award

Chan S, Benneker L M, Gantenbein-Ritter B
Ein reproduzierbares Papain-induziertes Bandscheibendegenerationsmodell mit reduziertem GAG und Wassergehalt
7. Deutscher Wirbelsäulenkongress, Stuttgart, Germany

Best Poster Award, 3rd Prize

Toporek G, Wallach D, Peterhans M, Vock J, Terribilini D, Fix M K, Manser P, Aebersold D M, Weber S
Integration of DICOM-RT into instrument guidance system for intra-operative interstitial HDR-Brachytherapy
26th International Congress on Computer Assisted Radiology and Surgery (CARS), Pisa, Italy

AWARDS

Best Poster Award

Ruppen J, Cortes-Dericks L, Marconi E, Schmid R, Karoubi G, Guenat O
Individual trapping of lung cancer cell spheroids on a microfluidic platform for chemosensitivity assays.
Swiss Society for Biomedical Engineering, EPFL, Lausanne, Switzerland

CTI Swiss MedTech Award Nominee

Studer H, Riedwyl H, Büchler P
Optimeyes: Computer Assisted Patient-Specific Refractive Surgery
Commission for Technology and Innovation CTI, Switzerland

CTI Swiss Medtech Best Poster Award

Guignard J, Wiedmer S, Arnold A, Auderset A, Schütz D, Kruse A, Uehlinger D, Caversaccio M, Frey F
Novel Body Access for Hemodialysis
Commission for Technology and Innovation CTI, Switzerland

euRobotics Technology Transfer Award

Nef T, Riener R, Duschau-Wicke A
ARMin: Robot-Assisted Neurorehabilitation of the Arm
European Robotics Forum, Odense, Denmark

Medical Cluster Award for best PhD Thesis

Studer H
Simulation of Refractive Surgery for Optimization of Vision Correction
Medical Cluster, Bern, Switzerland

Medvis Award for Medical Visualization, 3rd Prize

Gavaghan K
Augmented Reality Image Overlay Projection for the Visualisation of Surgical Guidance Data
German Society for Computer Science and the German Society for Computer and Robot-Assisted Surgery CURAC,
Düsseldorf, Germany

MICCAI Brain Tumor Segmentation Challenge, 2nd Prize

Bauer S
Segmentation of Brain Tumor Images Based on Integrated Hierarchical Classification and Regularization
15th International Conference on Medical Image Computing and Computer Assisted Interventions MICCAI, Nice, France

Ypsomed Innovationspreis 2012

Bell B, Caversaccio M, Weber S
Minimalinvasive roboterbasierte Cochleaimplantation
Ypsomed Innovationsfonds, Burgdorf, Switzerland

Imprint

Annual Report 2012

Editor: University of Bern

ARTORG Center for Biomedical Engineering Research

Institute for Surgical Technology and Biomechanics

Layout: ThinkNEO GmbH, 3012 Bern

Print: Schenker Druck AG, 3014 Bern

University of Bern
ARTORG Center for Biomedical Engineering Research
Head Office
Murtenstrasse 50
Postfach 44
3010 Bern, Switzerland

Phone +41 31 632 75 75
Fax +41 31 632 75 76
Email artorg@artorg.unibe.ch
www.artorg.unibe.ch

University of Bern
Institute for Surgical Technology and Biomechanics
Head Office
Stauffacherstr. 78
3014 Bern, Switzerland

Phone +41 31 631 59 59
Fax +41 31 631 59 60
Email contact@istb.unibe.ch
www.istb.unibe.ch